



*Fine Lighting
Crafted in the American
Tradition*

2018

The Simple Life

The Arts and Crafts movement of the early 20th Century was a reaction to the design excesses and mass production of the Industrial Age. It emphasized design that was simple, hand-crafted and true to the nature of the materials from which it was made.

The creative influences of designers and artisans such as Frank Lloyd Wright, Elbert Hubbard, Charles and Henry Greene, Dirk Van Erp, Gustav Stickley and Louis Comfort Tiffany established this quintessential American art form. Harmoniously uniting organic architecture and hand-crafted furnishings this form encourages a simpler lifestyle and a return to basics.

Southern Californian artists and architects involved in this movement found special forms of inspiration and opportunity along the Arroyo Seco. An outgrowth of desire for a connection between nature and the creative process was The Arroyo Guild of Fellow Craftsman. The Arroyo Guild published a pamphlet entitled "Arroyo Craftsman" in 1909 that captured the community's collective imagination by championing man's innate need to create beautiful things with his own hands.

In the late 1980's, a Pasadena artisan, who had grown up surrounded by the "ultimate bungalows" of the Greene Brothers, believed that the time had come again to embrace the design and lifestyle promoted by the Arts and Crafts movement and created what became Arroyo Craftsman.

Arroyo Craftsman designs and manufactures fine architectural and landscape lighting that honors the traditions of elegant simplicity combined with quality craftsmanship established by the founders of the American Arts and Crafts movement. Our creative interpretations of this design aesthetic and strict attention to quality have made us the premier manufacturer of contemporary Arts and Crafts inspired lighting.

"Gradually the dweller in the simple home will come to ponder upon the meaning of art....it will then become apparent how truly the home is the real art center."

—Charles Keeler



What makes Arroyo Craftsman special?

Arroyo Craftsman is known for the myriad options it offers in glass and finishes and the scalability of its designs. Commercial grade quality and in house metalworking make us the choice for many institutional, commercial, and residential projects that require larger fixtures. Many historical registers have used either catalogued or custom product from Arroyo Craftsman.

We are capable of designing and creating custom fixtures for your project in a variety of sizes and styles, or modifying our current fixtures to suit your needs. Please contact your local lighting supplier or Arroyo Craftsman sales representative for information on how to order custom product.

Custom Capabilities

We pride ourselves on our attention to detail, hand finishing, and quality. Because of that, and a variety of choices in metal finish and glass combinations, we offer the finest quality and greatest selection in Arts and Crafts inspired lighting available.



























The beauty of our product is more than skin deep. Our fixtures are made of heavier gauge brass than is common, giving them a more substantial appearance and increased durability. The rivets we use on many of our fixtures provide both beauty and additional structural integrity. Our glass panels are installed with both retaining clips and silicone to ensure that they are secured and will not rattle in the wind.

Our hand applied finishes are the best in the industry because we take the time to let them mature. The Mission Brown, Bronze, Raw Copper and Verdigris Patina undergo an intensive and time consuming process resulting in a complex and naturally aged appearance. All of our hand applied metal finishes will continue to mature and change with time.



Table of Contents

	Metal & Glass Finishes _____ 4		Dartmouth _____ 51
	Aberdeen _____ 7		Devonshire _____ 53
	A-Line _____ 8		Etoile _____ 54
	Anfield _____ 10		Evergreen _____ 57
	Asheville _____ 11		Exeter _____ 65
	Avenue _____ 14		Finsbury _____ 68
	Barcelona _____ 16		Franklin _____ 72
	Berkeley _____ 17		Glasgow _____ 74
	Bexley _____ 33		Glencoe _____ 84
	Bournemouth _____ 35		Hampton _____ 87
	Brighton _____ 36		Hartford _____ 89
	Canterbury _____ 38		Huntington _____ 93
	Carmel _____ 42		Inverness _____ 100
	Croydon _____ 48		

	Katsura _____	105		Prairie _____	151
	Kennebec _____	108		Providence _____	157
	Lancaster _____	110		Raymond _____	159
	Lyon _____	112		Ruskin _____	162
	Mission _____	114		Saint Clair _____	165
	Monterey _____	124		Saint George _____	168
	Nantes _____	129		Santorini _____	171
	Newport _____	131		Scottsdale _____	172
	Nottingham _____	138		Simplicity _____	173
	Oak Park _____	141		Sydney _____	175
	Orpington _____	144		Timber Ridge _____	177
	Pagoda _____	145		Valencia _____	181
	Pasadena _____	148		Vintage _____	186

Metal Finishes

Our hand applied finishes are the best in the industry because we take the time to let them "mature". Verdigris Patina, Raw Copper, Mission Brown and Bronze finishes are of an organic nature and are the result of an intensive three day oxidation process resulting in a complex and naturally aged appearance. Actual patterns and coloration of the metal finishes may vary from the images shown in this catalog, in fact may vary from product to product. This is due to the nature of the product and our hand-finishing. Our finishes will darken with age and weathering.

Powder coated finishes are durable and consistent.

Lacquer is a coating used on the following finishes: Antique Brass, Antique Copper, Bronze, & Verdigris Patina. Due to EPA standards we may only use a water based lacquer. This type of lacquer is less durable than a solvent based lacquer and will dissipate over time. This process will vary greatly depending on the environment. Periodically applying a wax on a lacquered surface will slow this process.

Oxidized Finishes



AB - Antique Brass

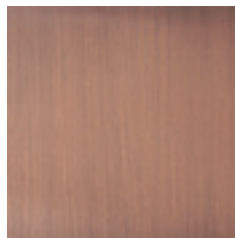

AC - Antique Copper



BZ - Bronze



MB - Mission Brown



RC - Raw Copper



VP - Verdigris Patina

Powder Coated Finishes

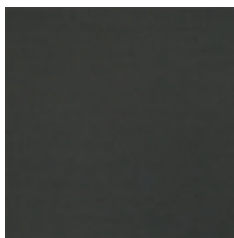

BK - Satin Black

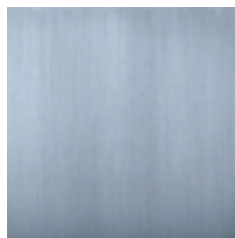

P - Pewter

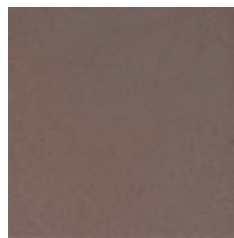

RB - Rustic Brown

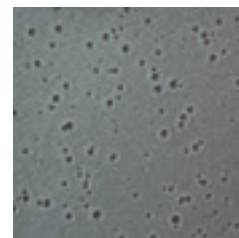

S - Slate



Glass Options



AE - Aerolite

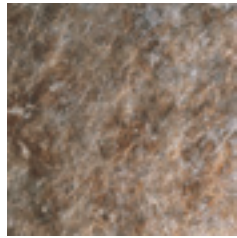

*AM - Almond Mica

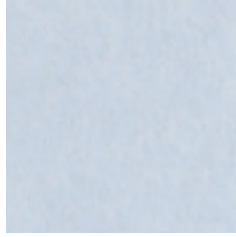

CLR - Clear



CR - Cream



CS - Clear Seedy

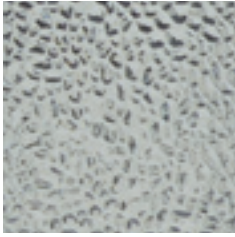

DD - Dew Drop



F - Frosted

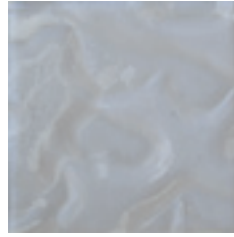

FL - Flemish



GW - Gold White Iridescent

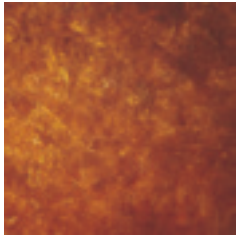

*M - Amber Mica



OF - Off White



RM - Rain Mist



TN - Tan



WO - White Opalescent

Glass Shade Combinations

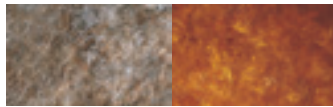

*MC - Almond Mica and Amber Mica combination

Offered in Ashville

***Mica is not recommended for outdoor use.**



GWC - Gold White Iridescent and White Opalescent combination

Offered in Etolile, Glasgow, Saint Clair



REC-Red and White Opalescent combination

Offered in Saint Clair



BC-Blue and White Opalescent Combination

Offered in Saint Clair

You are the Artist!

By offering several glass, finish, and scaling options within each thematic family, we allow you to design the product that specifically meets your aesthetic and functional needs.

Our product numbers are configured to let you choose the family style, application, size, decorative overlay (where applicable), glass/diffuser, and metal finish.

For example: the **CP-15TGW-BZ** is a combination of **C** (Carmel family), **P** (post mount), **15** (15 inch roof size), **T** (T-bar overlay), **GW** (gold white iridescent glass), **BZ** (bronze metal finish).

By organizing our product line and operations this way we empower you to become the artist that is inherent in all of us.

CARMEL POST MOUNT

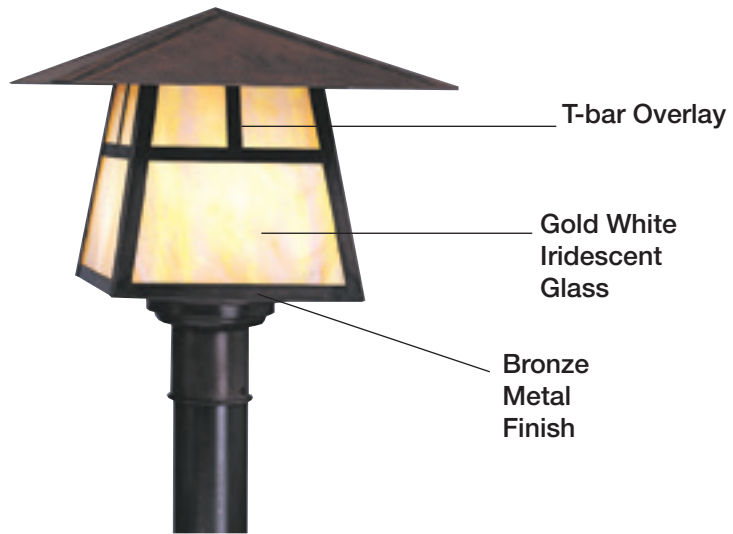

How we measure.

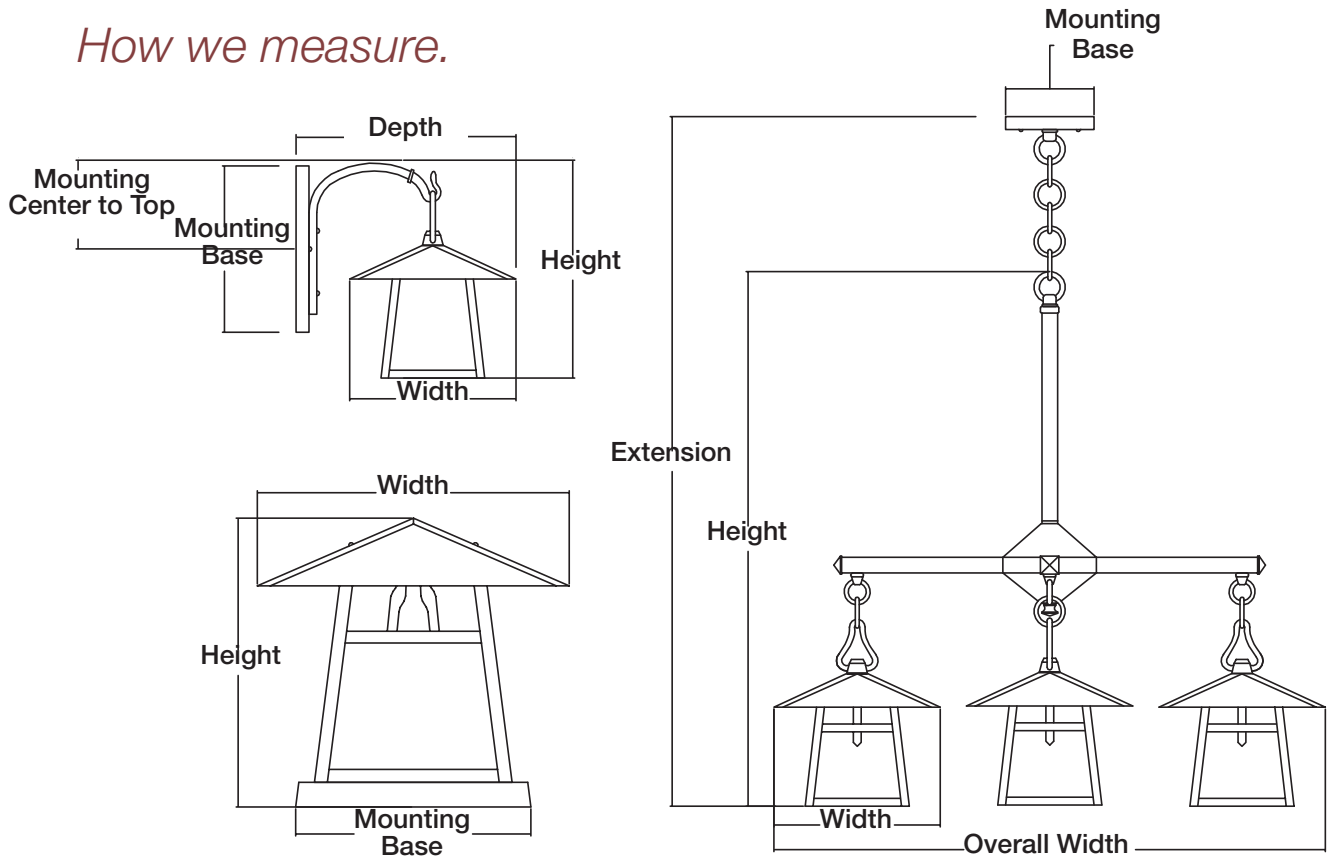

Aberdeen

Wall Mounts, Pendants & Column Mount



ABB-7TN-BZ
 Frame: ABB-7
 Glass: Tan (TN)
 Finish: Bronze (BZ)



ABB-9GW-MB
 Frame: ABB-9
 Glass: Gold White Iridescent (GW)
 Finish: Mission Brown (MB)

Specifications

Frame	Width	Height	Depth	Extension	Mounting Base	Mounting Center to Top	Lamping	C-UL Rating
ABB-7	7"	14"	9 5/8"		5" x 8"	4"	1-72W, Medium	Incand. Wet
ABB-9	8 1/2"	17"	12"		5" x 9"	4 1/2"	1-72W, Medium	Incand. Wet
ABH-7	7"	14"		50"	4 1/4" sq.		1-72W, Medium	Incand. Damp
ABH-9	8 1/2"	16 1/2"		52 1/2"	4 1/4" sq.		1-72W, Medium	Incand. Damp



ABH-7GW-VP
 Frame: ABH-7
 Glass: Gold White Iridescent (GW)
 Finish: Verdigris Patina (VP)



ABH-9WO-BK
 Frame: ABH-9
 Glass: White Opalescent (WO)
 Finish: Satin Black (BK)



ABC-15RM-MB
 Frame: ABC-15
 Glass: Rain Mist (RM)
 Finish: Mission Brown (MB)

Specifications

Frame	Width	Height	Mounting Base	Lamping	C-UL Rating
ABC-15	15"	7 1/2"	15 1/2" sq.	1-72W, Medium	Incand. Wet



AWS-1TGW-VP
 Frame: AWS-1
 Overlay: T-bar (T)
 Glass: Gold White Iridescent (GW)
 Finish: Verdigris Patina (VP)

AS-1TGW-MB

Frame: AS-1
 Overlay: T-bar (T)
 Glass: Gold White Iridescent (GW)
 Finish: Mission Brown (MB)



AS-2TCS-BZ

Frame: AS-2
 Overlay: T-bar (T)
 Glass: Clear Seedy (CS)
 Finish: Bronze (BZ)



AB-1EWO-VP

Frame: AB-1
 Overlay: Empty (E)
 Glass: White Opalescent (WO)
 Finish: Verdigris Patina (VP)

AS-3EWO-P

Frame: AS-3
 Overlay: Empty (E)
 Glass: White Opalescent (WO)
 Finish: Pewter (P)

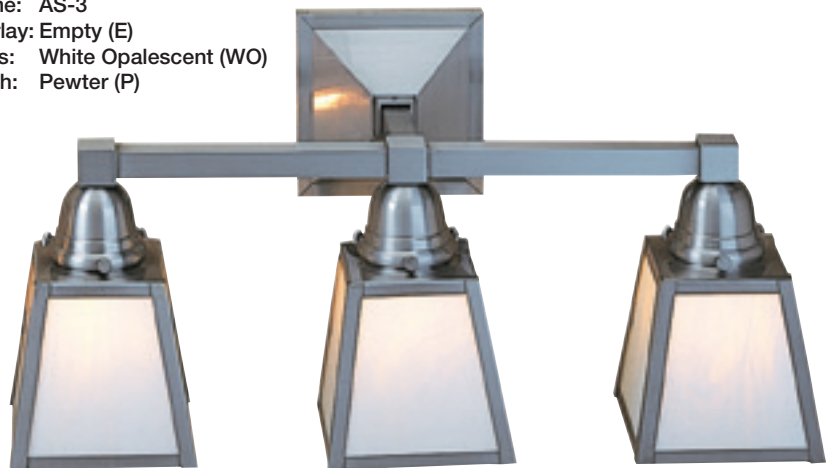

Specifications

Frame	Width	Overall Width	Height	Depth	Mounting Base	Mounting Center to Top	Lamping	C-UL Rating
AB-1	4 3/4"		9"	7 5/8"	4" x 6"	3/4"	1-60W, Medium	Incand. Damp
AS-1	4 3/4"	5"	9 3/4"	7 1/4"	5" sq.	2 1/2"	1-60W, Medium	Incand. Dry
AS-2	4 3/4"	12 3/4"	9 3/4"	7 1/4"	5" sq.	2 1/2"	2-60W, Medium	Incand. Dry
AS-3	4 3/4"	20 3/4"	9 3/4"	7 1/4"	5" sq.	2 1/2"	3-60W, Medium	Incand. Dry
AWS-1	4 3/4"		16"	6 7/8"	4 1/4" x 16"	8"	1-60W, Medium	Incand. Dry

ACM-4TCR-BZ

Frame: ACM-4
 Overlay: T-bar (T)
 Glass: Cream (CR)
 Finish: Bronze (BZ)



AH-1EGW-BZ

Frame: AH-1
 Overlay: Empty (E)
 Glass: Gold White Iridescent (GW)
 Finish: Bronze (BZ)



ASH-1TWO-P

Frame: ASH-1
 Overlay: T-bar (T)
 Glass: White Opalescent (WO)
 Finish: Pewter (P)



Overlay Design Options



T-bar, (T)

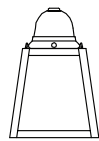

Empty (E)

Specifications

Frame	Body Width	Overall Width	Height	Extension	Mounting Base	Lamping	C-UL Rating
ACM-4	4 3/4"	16 3/4"	10 1/4"		15" sq.	4-60W, Medium	Incand. Dry
AH-1	4 3/4"		7 7/8"	43 7/8"	4 1/4" sq.	1-60W, Medium	Incand. Damp
ASH-1	4 3/4"		6 3/4"	30"	4 1/4" sq.	1-60W, Medium	Incand. Dry



ANB-6CS-MB
 Frame: ANB-6
 Glass: Clear Seedy (CS)
 Finish: Mission Brown (MB)



ANB-8WO-BZ
 Frame: ANB-8
 Glass: White Opalescent (WO)
 Finish: Bronze (BZ)



ANH-6RM-RC
 Frame: ANH-6
 Glass: Rain Mist (RM)
 Finish: Raw Copper (RC)



ANH-8CR-BZ
 Frame: ANH-8
 Glass: Cream (CR)
 Finish: Bronze (BZ)

Specifications

Frame	Width	Height	Depth	Extension	Mounting Base	Mounting Center to Top	Lamping	C-UL Rating
ANB-6	6 3/8"	10 3/4"	7"		4 1/4" sq.	2 1/8"	1-100W, Medium	Incand. Wet
ANB-8	8"	13"	9"		4" x 6"	3"	1-100W, Medium	Incand. Wet
ANH-6	6"	11 1/2"		49"	4 1/4" sq.		1-100W, Medium	Incand. Damp
ANH-8	8"	14 1/2"		50 1/2"	4 1/4" sq.		1-100W, Medium	Incand. Damp



AS-8MC-BZ

Frame: AS-8
 Glass: Almond Mica and Amber Mica Combination (MC)
 Finish: Bronze (BZ)



AS-12GW-VP

Frame: AS-12
 Glass: Gold White Iridescent (GW)
 Finish: Verdigris Patina (VP)



AS-16WO-BK

Frame: AS-16
 Glass: White Opalescent (WO)
 Finish: Satin Black (BK)

Specifications

Frame	Width	Height	Depth	Mounting Center to Top	Lamping	C-UL Rating
AS-8	8"	11 ½"	4"	5 ¾"	2-60W, Candle	Incand. Dry
AS-12	12"	17"	6"	8 ½"	2-60W, Medium	Incand. Dry
AS-16	16"	22 ¾"	8"	11 ¾"	2-60W, Medium	Incand. Dry



AH-12AM-BZ
 Frame: AH-12
 Glass: Almond Mica (AM)
 Finish: Bronze (BZ)



AH-8TN-RC
 Frame: AH-8
 Glass: Tan (TN)
 Finish: Raw Copper (RC)



ASH-12WO-BZ
 Frame: ASH-12
 Glass: White Opalescent (WO)
 Finish: Bronze (BZ)



ASH-8WO-BZ
 Frame: ASH-8
 Glass: White Opalescent (WO)
 Finish: Bronze (BZ)

Specifications

Frame	Width	Height	Extension	Mounting Base	Lamping	C-UL Rating
AH-8	8"	13 1/8"	49 1/8"	4 1/4" sq.	1-100W, Medium	Incand. Dry
AH-12	12"	18"	54"	4 1/4" sq.	1-100W, Medium	Incand. Dry
ASH-8	8"	13"	42 1/4"	4 1/4" sq.	1-100W, Medium	Incand. Dry
ASH-12	12"	18 3/8"	48 1/2"	4 1/4" sq.	1-100W, Medium	Incand. Dry

PENDANT MOUNTING BASE







AVB-6GW-BZ
 Frame: AVB-6
 Glass: Gold White Iridescent (GW)
 Finish: Bronze (BZ)



AVB-8GW-BZ
 Frame: AVB-8
 Glass: Gold White Iridescent (GW)
 Finish: Bronze (BZ)



AVH-8GW-VP
 Frame: AVH-8
 Glass: Gold White Iridescent (GW)
 Finish: Verdigris Patina (VP)



AVB-8LGW-BZ
 Frame: AVB-8L
 Glass: Gold White Iridescent (GW)
 Finish: Bronze (BZ)

Specifications

Frame	Width	Height	Depth	Extension	Mounting Base	Mounting Center to Top	Lamping	C-UL Rating
AVB-6	5 7/8"	12 3/4"	7 1/2"		5" x 11"	5 1/2"	1-100W, Medium	Incand. Wet
AVB-8	7 1/2"	15 7/8"	9 1/4"		6" x 15"	7 1/2"	1-100W, Medium	Incand. Wet
AVB-8L	7 1/2"	17 3/4"	9 1/4"		6" x 15"	7 1/2"	1-100W, Medium	Incand. Wet
AVH-8	7 1/2"	14 3/4"		53"	4 1/4" sq.		1-100W, Medium	Incand. Damp



AVC-6CS-BK

Frame: AVC-6
 Glass: Clear Seedy (CS)
 Finish: Satin Black (BK)



AVC-8WO-RC

Frame: AVC-8
 Glass: White Opalescent (WO)
 Finish: Raw Copper (RC)



AVP-8GW-AB

Frame: AVP-8
 Glass: Gold White Iridescent (GW)
 Finish: Antique Brass (AB)

Specifications

Frame	Width	Height	Mounting Base	Lamping	C-UL Rating
AVC-6	5 7/8"	11"	6 3/4" sq.	1-100W, Medium	Incand. Wet
AVC-8	7 1/2"	13 1/2"	9 1/4" sq.	1-100W, Medium	Incand. Wet
AVP-8	7 1/2"	13"		1-100W, Medium	Incand. Wet

Barcelona

Wall Mounts & Pendant

BAW-8DD-BZ

Frame: BAW-8
Glass: Dew Drop (DD)
Finish: Bronze (BZ)



BAW-6WO-BZ

Frame: BAW-6
Glass: White Opalescent (WO)
Finish: Bronze (BZ)



BAW-10CS-BZ

Frame: BAW-10
Glass: Clear Seedy (CS)
Finish: Bronze (BZ)



BAH-12DD-BZ

Frame: BAH-12
Glass: Dew Drop (DD)
Finish: Bronze (BZ)

Specifications

Frame	Width	Height	Depth	Extension	Mounting Base	Mounting Center to Top	Lamping	C-UL Rating
BAW-6	5 3/4"	11"	6 1/2"		5 1/4" x 6"	5 1/4"	1-100W, Medium	Incand. Wet
BAW-8	7 1/2"	18 1/2"	8"		7" x 8"	6 1/2"	2-60W, Candle Clear	Incand. Wet
BAW-10	9 1/2"	24"	10 1/2"		9" x 11"	9"	2-60W, Candle Clear	Incand. Wet
BAH-12	12"	18"		54"	4 1/4" sq.		4-60W, Candle Clear	Incand. Damp

Berkeley

Brass rivets provide both structural integrity and decorative detail in these fixtures inspired by the works of Dirk Van Erp and Gustav Stickley.





BB-7WO-BK
 Frame: BB-7
 Glass: White Opalescent (WO)
 Finish: Satin Black (BK)



BB-6LGW-RC
 Frame: BB-6L
 Glass: Gold White Iridescent (GW)
 Finish: Raw Copper (RC)



BB-6CR-BZ
 Frame: BB-6
 Glass: Cream (CR)
 Finish: Bronze (BZ)



BB-6SOF-BK
 Frame: BB-6S
 Glass: Off White (OF)
 Finish: Satin Black (BK)



BB-7LWO-BK
 Frame: BB-7L
 Glass: White Opalescent (WO)
 Finish: Satin Black (BK)



BB-8GW-VP
 Frame: BB-8
 Glass: Gold White Iridescent (GW)
 Finish: Verdigris Patina (VP)



BB-14TL-WO-VP
 Frame: BB-14TL
 Glass: White Opalescent (WO)
 Finish: Verdigris Patina (VP)

Specifications

Frame	Width	Height	Depth	Mounting Base	Mounting Center to Top	Lamping	C-UL Rating
BB-6S	5 5/8"	10 3/8"	7 7/8"	5" dia.	2 1/2"	1-60W, A15	Incand. Damp
BB-6	5 5/8"	12 1/2"	7 7/8"	5" dia.	2 1/2"	1-100W, Medium	Incand. Damp
BB-6L	5 5/8"	14 3/8"	7 7/8"	5" dia.	2 1/2"	1-100W, Medium	Incand. Damp
BB-7	7"	15 3/8"	9 5/8"	6 1/4" dia.	3 1/8"	1-100W, Medium	Incand. Damp
BB-7L	7"	17 5/8"	9 5/8"	6 1/4" dia.	3 1/8"	1-100W, Medium	Incand. Damp
BB-8	8 3/8"	17 7/8"	11"	7 1/2" dia.	3 3/4"	1-100W, Medium	Incand. Damp
BB-14TL	14"	27 1/4"	18 1/2"	6" x 15"	6 1/2"	1-150W, Medium	Incand. Damp



BB-6SWOF-RC
 Frame: BB-6SW
 Glass: Off White (OF)
 Finish: Raw Copper (RC)

Solid ball attachment
 for wet locations.



BB-6WF-BZ
 Frame: BB-6W
 Glass: Frosted (F)
 Finish: Bronze (BZ)



BB-6LWF-BZ
 Frame: BB-6LW
 Glass: Frosted (F)
 Finish: Bronze (BZ)



BB-7WGW-RC
 Frame: BB-7W
 Glass: Gold White Iridescent (GW)
 Finish: Raw Copper (RC)



BB-7LWGW-RC
 Frame: BB-7LW
 Glass: Gold White Iridescent (GW)
 Finish: Raw Copper (RC)



BB-8WF-BZ
 Frame: BB-8W
 Glass: Frosted (F)
 Finish: Bronze (BZ)

Specifications

Frame	Width	Height	Depth	Mounting Base	Mounting Center to Top	Lamping	C-UL Rating
BB-6SW	5 5/8"	9 5/8"	8"	5" dia.	2 1/2"	1-60W, A15	Incand. Wet
BB-6W	5 5/8"	11 3/4"	8"	5" dia.	2 1/2"	1-100W, Medium	Incand. Wet
BB-6LW	5 5/8"	13 5/8"	8"	5" dia.	2 1/2"	1-100W, Medium	Incand. Wet
BB-7W	7"	14 3/4"	9 3/4"	6 1/4" dia.	3 1/8"	1-100W, Medium	Incand. Wet
BB-7LW	7"	17"	9 3/4"	6 1/4" dia.	3 1/8"	1-100W, Medium	Incand. Wet
BB-8W	8 3/8"	17 3/8"	11 1/8"	7 1/2" dia.	3 3/4"	1-100W, Medium	Incand. Wet



BB-11GW-VP

Frame: BB-11
Glass: Gold White Iridescent (GW)
Finish: Verdigris Patina (VP)



BB-11LWO-AC

Frame: BB-11L
Glass: White Opalescent (WO)
Finish: Antique Copper (AC)



BB-14OF-MB

Frame: BB-14
Glass: Off White (OF)
Finish: Mission Brown (MB)



BB-14LWO-AC

Frame: BB-14L
Glass: White Opalescent (WO)
Finish: Antique Copper (AC)

Specifications

Frame	Width	Height	Depth	Mounting Base	Mounting Center to Top	Lamping	C-UL Rating
BB-11	11"	11 7/8"	15"	4 1/2" x 9"	5 1/16"	1-100W, Medium	Incand. Damp
BB-11L	11"	14 5/8"	15"	4 1/2" x 9"	5 1/16"	1-100W, Medium	Incand. Damp
BB-14	14 1/8"	15"	18 1/2"	5" x 11"	6 13/16"	1-100W, Medium	Incand. Damp
BB-14L	14 1/8"	19"	18 1/2"	5" x 11"	6 13/16"	1-100W, Medium	Incand. Damp



BS-6RGW-AC

Frame: BS-6R
Glass: Gold White Iridescent (GW)
Finish: Antique Copper (AC)



BS-6LRGW-RC

Frame: BS-6LR
Glass: Gold White Iridescent (GW)
Finish: Raw Copper (RC)



BS-7RGW-VP

Frame: BS-7R
Glass: Gold White Iridescent (GW)
Finish: Verdigris Patina (VP)



BS-7LRGW-RC

Frame: BS-7LR
Glass: Gold White Iridescent (GW)
Finish: Raw Copper (RC)



BS-8RWO-BZ

Frame: BS-8R
Glass: White Opalescent (WO)
Finish: Bronze (BZ)

Specifications

Frame	Width	Height	Depth	Mounting Base	Mounting Center to Top	Lamping	C-UL Rating
BS-6R	5 5/8"	9 1/4"	6 1/2"	4" x 6"	5 9/16"	1-100W, Medium	Incand. Wet
BS-6LR	5 5/8"	11 1/8"	6 1/2"	4" x 8"	6 1/2"	1-100W, Medium	Incand. Wet
BS-7R	7"	11 1/4"	8 1/4"	4" x 8"	6 13/16"	1-100W, Medium	Incand. Wet
BS-7LR	7"	13 1/2"	8 1/4"	4" x 8"	8"	1-100W, Medium	Incand. Wet
BS-8R	8 3/8"	13 1/4"	9 1/2"	4" x 8"	8"	1-100W, Medium	Incand. Wet

BH-6SWO-BK

Frame: BH-6S
Glass: White Opalescent (WO)
Finish: Satin Black (BK)



BH-6OF-BZ

Frame: BH-6
Glass: Off White (OF)
Finish: Bronze (BZ)

BH-6LTN-BZ

Frame: BH-6L
Glass: Tan (TN)
Finish: Bronze (BZ)

BH-7WO-VP

Frame: BH-7
Glass: White Opalescent (WO)
Finish: Verdigris Patina (VP)



BH-14TLWO-VP

Frame: BH-14TL
Glass: White Opalescent (WO)
Finish: Verdigris Patina (VP)



BH-7LCR-VP

Frame: BH-7L
Glass: Cream (CR)
Finish: Verdigris Patina (VP)

BH-8WO-VP

Frame: BH-8
Glass: White Opalescent (WO)
Finish: Verdigris Patina (VP)

Specifications

Frame	Width	Height	Extension	Mounting Base	Lamping	C-UL Rating
BH-6S	5 5/8"	8"	44"	5" dia.	1-60W, A15	Incand. Damp
BH-6	5 5/8"	10 1/8"	46 1/8"	5" dia.	1-100W, Medium	Incand. Damp
BH-6L	5 5/8"	12"	48"	5" dia.	1-100W, Medium	Incand. Damp
BH-7	7"	12 3/8"	48 3/8"	5" dia.	1-100W, Medium	Incand. Damp
BH-7L	7"	14 5/8"	50 5/8"	5" dia.	1-100W, Medium	Incand. Damp
BH-8	8 3/8"	14 1/4"	50 1/4"	5" dia.	1-100W, Medium	Incand. Damp
BH-14TL	14"	24 3/4"	60 3/4"	5" dia.	1-150W, Medium	Incand. Damp



BH-11OF-VP

Frame: BH-11
Glass: Off White (OF)
Finish: Verdigris Patina (VP)



BH-11LWO-BK

Frame: BH-11L
Glass: White Opalescent (WO)
Finish: Satin Black (BK)



BH-14F-P

Frame: BH-14
Glass: Frosted (F)
Finish: Pewter (P)



BH-14LCR-MB

Frame: BH-14L
Glass: Cream (CR)
Finish: Mission Brown (MB)



BH-17OF-VP

Frame: BH-17
Glass: Off White (OF)
Finish: Verdigris Patina (VP)



BH-17LWO-BZ

Frame: BH-17L
Glass: White Opalescent (WO)
Finish: Bronze (BZ)

Specifications

Frame	Width	Height	Extension	Mounting Base	Lamping	C-UL Rating
BH-11	11"	10 1/8"	46 1/8"	5" dia.	1-100W, Medium	Incand. Damp
BH-11L	11"	12 7/8"	48 7/8"	5" dia.	1-100W, Medium	Incand. Damp
BH-14	14 1/8"	12 5/8"	48 5/8"	5" dia.	1-100W, Medium	Incand. Damp
BH-14L	14 1/8"	16 5/8"	52 5/8"	5" dia.	1-100W, Medium	Incand. Damp
BH-17	17"	14 7/8"	50 7/8"	5" dia.	1-150W, Medium	Incand. Damp
BH-17L	17"	20 1/8"	56 1/8"	5" dia.	1-150W, Medium	Incand. Damp

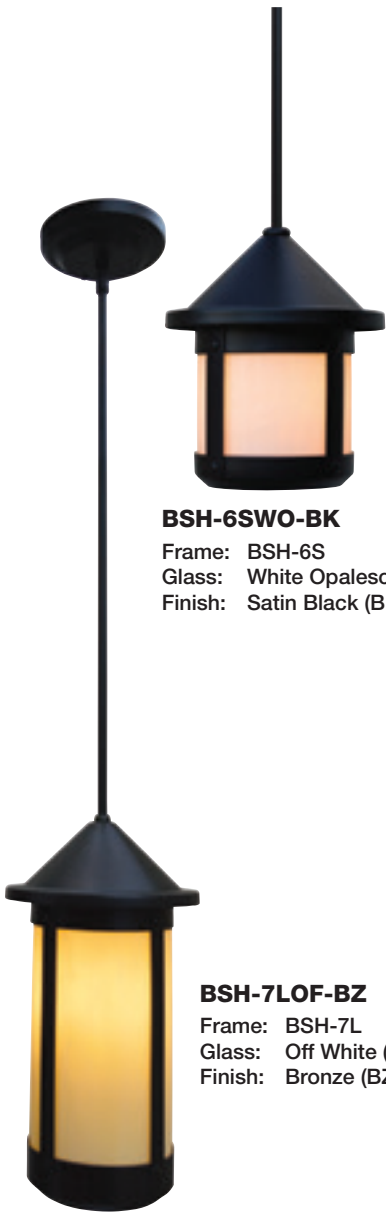

BSH-6SWO-BK

Frame: BSH-6S
Glass: White Opalescent (WO)
Finish: Satin Black (BK)



BSH-6TN-RC

Frame: BSH-6
Glass: Tan (TN)
Finish: Raw Copper (RC)



BSH-6LGW-BZ

Frame: BSH-6L
Glass: Gold White
Iridescent (GW)
Finish: Bronze (BZ)



BSH-7TN-RC

Frame: BSH-7
Glass: Tan (TN)
Finish: Raw Copper (RC)

BSH-7LOF-BZ

Frame: BSH-7L
Glass: Off White (OF)
Finish: Bronze (BZ)



BSH-8F-RC

Frame: BSH-8
Glass: Frosted (F)
Finish: Raw Copper (RC)



BSH-14TLWO-VP

Frame: BSH-14TL
Glass: White Opalescent (WO)
Finish: Verdigris Patina (VP)

Specifications

Frame	Width	Height	Extension	Mounting Base	Lamping	C-UL Rating
BSH-6S	5 5/8"	6 1/2"	29 1/2"	4 1/4" dia.	1-60W, A15	Incand. Wet
BSH-6	5 5/8"	8 5/8"	31 5/8"	4 1/4" dia.	1-100W, Medium	Incand. Wet
BSH-6L	5 5/8"	10 1/2"	33 1/2"	4 1/4" dia.	1-100W, Medium	Incand. Wet
BSH-7	7"	10 5/8"	33 3/4"	4 1/4" dia.	1-100W, Medium	Incand. Wet
BSH-7L	7"	12 7/8"	36"	4 1/4" dia.	1-100W, Medium	Incand. Wet
BSH-8	8 3/8"	12 5/8"	35 3/4"	4 1/4" dia.	1-100W, Medium	Incand. Wet
BSH-14TL	14"	21 3/8"	44 5/8"	4 1/4" dia.	1-150W, Medium	Incand. Wet



BSH-14OF-MB

Frame: BSH-14
Glass: Off White (OF)
Finish: Mission Brown (MB)



BSH-14LCR-MB

Frame: BSH-14L
Glass: Cream (CR)
Finish: Mission Brown (MB)

BSH-11GW-VP

Frame: BSH-11
Glass: Gold White
Iridescent (GW)
Finish: Verdigris Patina (VP)

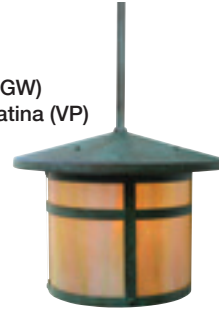

BSH-11LCR-MB

Frame: BSH-11L
Glass: Cream (CR)
Finish: Mission Brown (MB)



BSH-17OF-VP

Frame: BSH-17
Glass: Off White (OF)
Finish: Verdigris Patina (VP)



BSH-17LWO-BZ

Frame: BSH-17L
Glass: White Opalescent (WO)
Finish: Bronze (BZ)

Specifications

Frame	Width	Height	Extension	Mounting Base	Lamping	C-UL Rating
BSH-11	11"	8 1/2"	31 3/4"	4 1/4" sq.	1-100W, Medium	Incand. Wet
BSH-11L	11"	11 1/4"	34 1/2"	4 1/4" sq.	1-100W, Medium	Incand. Wet
BSH-14	14 1/8"	10 3/8"	33 5/8"	4 1/4" sq.	1-100W, Medium	Incand. Wet
BSH-14L	14 1/8"	14 3/8"	37 5/8"	4 1/4" sq.	1-100W, Medium	Incand. Wet
BSH-17	17"	12 5/8"	35 7/8"	4 1/4" sq.	1-150W, Medium	Incand. Wet
BSH-17L	17"	17 7/8"	41 1/8"	4 1/4" sq.	1-150W, Medium	Incand. Wet



BCM-6S/3OF-BZ
 Frame: BCM-6S/3
 Glass: Off White (OF)
 Finish: Bronze (BZ)



BCM-10WO-P
 Frame: BCM-10
 Glass: White Opalescent (WO)
 Finish: Pewter (P)



BCM-8GW-VP
 Frame: BCM-8
 Glass: Gold White Iridescent (GW)
 Finish: Verdigris Patina (VP)



BCM-12CR-BZ
 Frame: BCM-12
 Glass: Cream (CR)
 Finish: Bronze (BZ)

Specifications

Frame	Width	Height	Extension	Mounting Base	Lamping	C-UL Rating
BCM-8	9 7/8"	6 3/8"		9 7/8" dia.	1-60W, Medium	Incand. Damp
BCM-10	12"	7 5/8"		12" dia.	2-60W, Medium	Incand. Damp
BCM-12	13 3/4"	8 1/2"		13 3/4" dia.	2-60W, Medium	Incand. Damp
BCM-6S/3	16"	10 3/8"		13 3/4" dia.	3-60W, A15	Incand. Dry

BCM-20GW-AB

Frame: BCMH-20
 Glass: Gold White Iridescent (GW)
 Finish: Antique Brass (AB)



BCM-6WO-P

Frame: BCMH-6
 Glass: White Opalescent (WO)
 Finish: Pewter (P)



BCM-6GW-BZ

Frame: BCM-6
 Glass: Gold White Iridescent (GW)
 Finish: Bronze (BZ)

Specifications

Frame	Width	Height	Extension	Mounting Base	Lamping	C-UL Rating
BCM-6	8 7/8"	13 1/4"		5" dia.	1-100W, Medium	Incand. Dry
BCM-6	8 7/8"	18"	54"	5" dia.	1-100W, Medium	Incand. Dry
BCM-20	19 3/8"	26 1/2"	62 1/2"	5" dia.	4-100W, Medium	Incand. Dry



BC-11GW-VP

Frame: BC-11
Glass: Gold White Iridescent (GW)
Finish: Verdigris Patina (VP)



BC-11LCS-VP

Frame: BC-11L
Glass: Clear Seedy (CS)
Finish: Verdigris Patina (VP)



BC-14GW-VP

Frame: BC-14
Glass: Gold White Iridescent (GW)
Finish: Verdigris Patina (VP)



BC-14LGW-RC

Frame: BC-14L
Glass: Gold White Iridescent (GW)
Finish: Raw Copper (RC)



BC-17WO-BZ

Frame: BC-17
Glass: White Opalescent (WO)
Finish: Bronze (BZ)



BC-17LWO-BZ

Frame: BC-17L
Glass: White Opalescent (WO)
Finish: Bronze (BZ)

Specifications

Frame	Width	Height	Mounting Base	Lamping	C-UL Rating
BC-11	11"	10 1/8"	10" dia.	1-100W, A19	Incand. Wet
BC-11L	11"	12 3/4"	10" dia.	1-100W, A19	Incand. Wet
BC-14	14"	12"	12" dia.	1-100W, A19	Incand. Wet
BC-14L	14"	16"	12" dia.	1-100W, A19	Incand. Wet
BC-17	17"	14 3/8"	13 3/4" dia.	1-100W, A19	Incand. Wet
BC-17L	17"	19 5/8"	13 3/4" dia.	1-100W, A19	Incand. Wet

Specifications

Frame	Width	Height	Lamping	C-UL Rating
BSP-6	5 5/8"	21"	1-60W, A19	Incand. Wet



BP-6GW-VP

Frame: BP-6
Glass: Gold White Iridescent (GW)
Finish: Verdigris Patina (VP)



BP-6LWO-VP

Frame: BP-6L
Glass: White Opalescent (WO)
Finish: Verdigris Patina (VP)



BSP-6WO-BK

Frame: BSP-6
Glass: White Opalescent (WO)
Finish: Satin Black (BK)

Specifications

Frame	Width	Height	Lamping	C-UL Rating
BP-6	5 5/8"	9 1/4"	1-60W, A19	Incand. Wet
BP-6L	5 5/8"	11 1/8"	1-60W, A19	Incand. Wet
BP-7	7"	11 1/4"	1-60W, A19	Incand. Wet
BP-7L	7"	13 5/8"	1-60W, A19	Incand. Wet
BP-8	8 3/8"	13 1/4"	1-60W, A19	Incand. Wet



BP-7TN-BZ

Frame: BP-7
Glass: Tan (TN)
Finish: Bronze (BZ)



BP-7LGW-BK

Frame: BP-7L
Glass: Gold White Iridescent (GW)
Finish: Satin Black (BK)



BP-8RM-RC

Frame: BP-8
Glass: Rain Mist (RM)
Finish: Raw Copper (RC)



BP-11WO-MB
 Frame: BP-11
 Glass: White Opalescent (WO)
 Finish: Mission Brown (MB)



BP-11LGW-VP
 Frame: BP-11L
 Glass: Gold White Iridescent (GW)
 Finish: Verdigris Patina (VP)



BP-14WO-BZ
 Frame: BP-14
 Glass: White Opalescent (WO)
 Finish: Bronze (BZ)



BP-14LGW-VP
 Frame: BP-14L
 Glass: Gold White Iridescent (GW)
 Finish: Verdigris Patina (VP)



BP-17WO-BZ
 Frame: BP-17
 Glass: White Opalescent (WO)
 Finish: Bronze (BZ)



BP-17LGW-VP
 Frame: BP-17L
 Glass: Gold White Iridescent (GW)
 Finish: Verdigris Patina (VP)

Specifications

Frame	Width	Height	Lamping	C-UL Rating
BP-11	11"	9 1/8"	1-100W, A19	Incand. Wet
BP-11L	11"	11 5/8"	1-100W, A19	Incand. Wet
BP-14	14"	11 1/8"	1-100W, A19	Incand. Wet
BP-14L	14"	15 1/8"	1-100W, A19	Incand. Wet
BP-17	17"	13 1/4"	1-100W, A19	Incand. Wet
BP-17L	17"	18 5/8"	1-100W, A19	Incand. Wet



LV12-B6SWO-RC

Frame: LV12-B6S
Glass: White Opalescent (WO)
Finish: Raw Copper (RC)



LV18-B6GW-RC

Frame: LV18-B6
Glass: Gold White
Iridescent (GW)
Finish: Raw Copper (RC)



LV24-B6LF-RC

Frame: LV24-B6
Glass: Frosted (F)
Finish: Raw Copper (RC)

Specifications

Frame	Width	Height	Lamping	C-UL Rating
LV12-B6S	5 5/8"	19 5/8"	1-18W, Low Voltage T-5 Wedge	Incand. Wet
LV12-B6	5 5/8"	21 1/4"	1-18W, Low Voltage T-5 Wedge	Incand. Wet
LV12-B6L	5 5/8"	23 1/8"	1-18W, Low Voltage T-5 Wedge	Incand. Wet
LV18-B6S	5 5/8"	25 5/8"	1-18W, Low Voltage T-5 Wedge	Incand. Wet
LV18-B6	5 5/8"	27 1/4"	1-18W, Low Voltage T-5 Wedge	Incand. Wet
LV18-B6L	5 5/8"	29 1/8"	1-18W, Low Voltage T-5 Wedge	Incand. Wet
LV24-B6S	5 5/8"	31 5/8"	1-18W, Low Voltage T-5 Wedge	Incand. Wet
LV24-B6	5 5/8"	33 1/4"	1-18W, Low Voltage T-5 Wedge	Incand. Wet
LV24-B6L	5 5/8"	35 1/8"	1-18W, Low Voltage T-5 Wedge	Incand. Wet

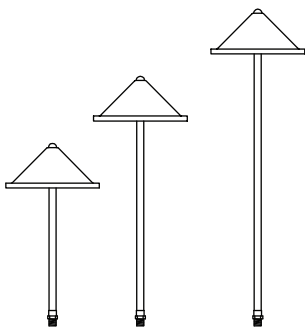

LV12-B8R LV18-B8R LV24-B8R

LV24-B8R-BZ

Frame: LV24-B8R
Finish: Bronze (BZ)



Specifications

Frame	Width	Height	Lamping	C-UL Rating
LV12-B8R	8 3/8"	15 1/2"	1-18W, Low Voltage T-5 Wedge	Incand. Wet
LV18-B8R	8 3/8"	21 1/2"	1-18W, Low Voltage T-5 Wedge	Incand. Wet
LV24-B8R	8 3/8"	27 1/2"	1-18W, Low Voltage T-5 Wedge	Incand. Wet



LV36-B6SWO-VP
 Frame: LV36-B6S
 Glass: White Opalescent (WO)
 Finish: Verdigris Patina (VP)



LV27-B6WO-BK
 Frame: LV27-B6
 Glass: White Opalescent (WO)
 Finish: Satin Black (BK)



LV36-B6LGW-VP
 Frame: LV36-B6L
 Glass: Gold White Iridescent (GW)
 Finish: Verdigris Patina (VP)

Specifications

Frame	Width	Height	Lamping	C-UL Rating
LV27-B6S	5 5/8"	27"	1-18W, Low Voltage T-5 Wedge	Incand. Wet
LV27-B6	5 5/8"	27"	1-18W, Low Voltage T-5 Wedge	Incand. Wet
LV27-B6L	5 5/8"	27"	1-18W, Low Voltage T-5 Wedge	Incand. Wet
LV27-B8R	8 3/8"	27"	1-18W, Low Voltage T-5 Wedge	Incand. Wet
LV36-B6S	5 5/8"	36"	1-18W, Low Voltage T-5 Wedge	Incand. Wet
LV36-B6	5 5/8"	36"	1-18W, Low Voltage T-5 Wedge	Incand. Wet
LV36-B6L	5 5/8"	36"	1-18W, Low Voltage T-5 Wedge	Incand. Wet
LV36-B8R	8 3/8"	36"	1-18W, Low Voltage T-5 Wedge	Incand. Wet



LVW-B8R-VP
 Frame: LVW-B8R
 Finish: Verdigris Patina (VP)

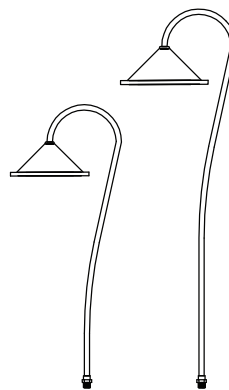

LV27-B8R LV36-B8R



LV36-B8R-S
 Frame: LV36-B8R
 Finish: Slate (S)

Specifications

Frame	Width	Height	Mounting Center to Top	Lamping	C-UL Rating
LVW-B8R	8 3/8"	3 3/8"	2"	1-18W, Low Voltage T-5 Wedge	Incand. Wet



BEB-7WO-S
 Frame: BEB-7
 Glass: White Opalescent (WO)
 Finish: Slate (S)

BEB-9WO-S
 Frame: BEB-9
 Glass: White Opalescent (WO)
 Finish: Slate (S)



BEH-7GW-BZ
 Frame: BEH-7
 Glass: Gold White Iridescent (GW)
 Finish: Bronze (BZ)

BEH-9GW-RC
 Frame: BEH-9
 Glass: Gold White Iridescent (GW)
 Finish: Raw Copper (RC)



Specifications

Frame	Width	Height	Depth	Extension	Mounting Base	Mounting Center to Top	Lamping	C-UL Rating
BEB-7	7"	16 ½"	10"		4" x 6"	9"	1-72W, Medium	Incand. Wet
BEB-9	9"	21 ¼"	13"		5" x 7 ½"	11"	1-72W, Medium	Incand. Wet
BEH-7	5"	14"		50"	4 ¼" sq.		1-72W, Medium	Incand. Damp
BEH-9	6 ⅜"	18"		54"	4 ¼" sq.		1-72W, Medium	Incand. Damp

BEC-15WO-P

Frame: BEC-15
 Glass: White Opalescent (WO)
 Finish: Pewter (P)



BEP-7TN-BZ

Frame: BEP-7
 Glass: Tan (TN)
 Finish: Bronze (BZ)



BEP-9WO-P

Frame: BEP-9
 Glass: White Opalescent (WO)
 Finish: Pewter (P)

Specifications

Frame	Width	Height	Mounting Base	Lamping	C-UL Rating
BEC-15	15"	8 ½"	17" sq.	1-72W, Medium	Incand. Wet
BEP-7	5"	12 ½"		1-72W, Medium	Incand. Wet
BEP-9	6 ¾"	17 ¼"		1-72W, Medium	Incand. Wet

Bournemouth

Wall Mounts, Pendant, Column & Post Mount



BOW-5CLR-BK

Frame: BOW-5
Glass: Clear (CLR)
Finish: Satin Black (BK)

BOW-8CS-BZ

Frame: BOW-8
Glass: Clear Seedy (CS)
Finish: Bronze (BZ)



BOW-10CS-BK

Frame: BOW-10
Glass: Clear Seedy (CS)
Finish: Satin Black (BK)



BOH-8CS-BZ

Frame: BOH-8
Glass: Clear Seedy (CS)
Finish: Bronze (BZ)



BOP-8CS-BZ

Frame: BOP-8
Glass: Clear Seedy (CS)
Finish: Bronze (BZ)



BOC-14DD-BZ

Frame: BOC-14
Glass: Dew Drop (DD)
Finish: Bronze (BZ)

Specifications

Frame	Width	Height	Depth	Extension	Mounting Base	Mounting Center to Top	Lamping	C-UL Rating
BOW-5	5"	7 1/2"	5 1/2"		4" x 4"	3"	1-100W, Medium	Incand. Wet
BOW-8	8"	15 1/2"	9"		7" x 6"	5"	2-60W, Candle Clear	Incand. Wet
BOW-10	10"	19 1/2"	11"		9" x 8"	6 1/2"	2-60W, Candle Clear	Incand. Wet
BOH-8	8"	17"	9"	53"	4 1/4" sq.		2-60W, Candle Clear	Incand. Damp
BOP-8	8"	15 1/2"	9"				2-60W, Candle Clear	Incand. Wet
BOC-14	14"	9"			14" sq.		4-60W, Candle Clear	Incand. Wet



BRB-8CLR/WHT-P

Frame: BRB-8
 Glass: Clear with White Inner Cylinder (CLR/WHT)
 Finish: Pewter (P)



BRB-10CLR/WHT-BZ

Frame: BRB-10
 Glass: Clear with White Inner Cylinder (CLR/WHT)
 Finish: Bronze (BZ)



BRH-10CLR/WHT-BK

Frame: BRH-10
 Glass: Clear with White Inner Cylinder (CLR/WHT)
 Finish: Satin Black (BK)

Specifications

Frame	Width	Height	Depth	Extension	Mounting Base	Mounting Center to Top	Lamping	C-UL Rating
BRB-8	8"	14"	9"		4" x 7"	10 ½"	1-72W, Medium	Incand. Wet
BRB-10	10"	18"	11"		5" x 12"	12 ½"	1-72W, Medium	Incand. Wet
BRH-10	10"	17 ½"		53 ½"	4 ¼" sq.		1-72W, Medium	Incand. Damp



BRC-8CLR/CS-BK

Frame: BRC-8
 Glass: Clear with Clear Seedy Cylinder (CLR/CS)
 Finish: Satin Black (BK)



BRC-10CLR/CS-P

Frame: BRC-10
 Glass: Clear with Clear Seedy Cylinder (CLR/CS)
 Finish: Pewter (P)



BRP-8CLR/WHT-RC

Frame: BRP-8
 Glass: Clear with White Inner Cylinder (CLR/WHT)
 Finish: Raw Copper (RC)

BRP-10CLR/CS-P

Frame: BRP-10
 Glass: Clear with
 Clear Seedy (CLR/CS)
 Finish: Pewter (P)



Specifications

Frame	Width	Height	Mounting Base	Lamping	C-UL Rating
BRC-8	8"	13"	6" sq.	1-72W, Medium	Incand. Wet
BRC-10	10"	17"	8" sq.	1-72W, Medium	Incand. Wet
BRP-8	8"	12"		1-72W, Medium	Incand. Wet
BRP-10	10"	15 ½"		1-72W, Medium	Incand. Wet



CAB-7CS-BZ
 Frame: CAB-7
 Glass: Clear Seedy (CS)
 Finish: Bronze (BZ)



CAB-7LCLR-BK
 Frame: CAB-7L
 Glass: Clear (CLR)
 Finish: Satin Black (BK)



CAB-9CS-RC
 Frame: CAB-9
 Glass: Clear Seedy (CS)
 Finish: Raw Copper (RC)

Specifications

Frame	Width	Height	Depth	Extension	Mounting Base	Mounting Center to Top	Lamping	C-UL Rating
CAB-7	7"	15"	9 1/4"		5" x 8"	10 1/2"	3-60W, Candle	Incand. Wet
CAB-7L	7"	22 1/2"	9 1/4"		5" x 15 1/2"	14 3/8"	3-60W, Candle	Incand. Wet
CAB-9	8 1/2"	30"	11 1/2"		8" x 21 1/4"	19"	4-60W, Candle	Incand. Wet

CAH-7LCS-AB

Frame: CAH-7L
 Glass: Clear Seedy (CS)
 Finish: Antique Brass (AB)



CAH-7CS-VP

Frame: CAH-7
 Glass: Clear Seedy (CS)
 Finish: Verdigris Patina (VP)

CAH-9CS-AB

Frame: CAH-9
 Glass: Clear Seedy (CS)
 Finish: Antique Brass (AB)



Specifications

Frame	Width	Height	Depth	Extension	Mounting Base	Mounting Center to Top	Lamping	C-UL Rating
CAH-7	7"	14"		51 5/8"	4 1/4" sq.		3-60W, Candle	Incand. Damp
CAH-7L	7"	19 1/4"		56 7/8"	4 1/4" sq.		3-60W, Candle	Incand. Damp
CAH-9	8 5/8"	24"		61 5/8"	4 1/4" sq.		3-60W, Candle	Incand. Damp



CAC-13AM-S
 Frame: CAC-13
 Glass: Almond Mica (AM)
 Finish: Slate (S)



CAC-16CS-BZ
 Frame: CAC-16
 Glass: Clear Seedy (CS)
 Finish: Bronze (BZ)



CAC-19CS-RC
 Frame: CAC-19
 Glass: Clear Seedy (CS)
 Finish: Raw Copper (RC)

Specifications

Frame	Width	Height	Mounting Base	Lamping	C-UL Rating
CAC-13	13"	11"	13" sq.	4-60W, Candle	Incand. Wet
CAC-16	17"	12 ¾"	17" sq.	4-60W, Candle	Incand. Wet
CAC-19	20"	15 ½"	20" sq.	4-60W, Candle	Incand. Wet



CAP-9RM-RC

Frame: CAP-9
 Glass: Rain Mist (RM)
 Finish: Raw Copper (RC)



CAP-7LRM-RC

Frame: CAP-7L
 Glass: Rain Mist (RM)
 Finish: Raw Copper (RC)



CAP-7CS-RC

Frame: CAP-7
 Glass: Clear Seedy (CS)
 Finish: Raw Copper (RC)

Specifications

Frame	Width	Height	Mounting Base	Lamping	C-UL Rating
CAP-7	7"	12 ¼"		3-60W, Candle	Incand. Wet
CAP-7L	7"	17"		3-60W, Candle	Incand. Wet
CAP-9	8 ½"	21 ¾"		3-60W, Candle	Incand. Wet

Carmel

The generous sloping roofs of these lamps are inspired by the classic architectural designs of the American Arts and Crafts movement of the early 1900's.



CB-8DDD-BZ

Frame: CB-8
 Overlay: Dart (D)
 Glass: Dew Drop (DD)
 Finish: Bronze (BZ)



CB-12TWO-RC

Frame: CB-12
 Overlay: T-bar (T)
 Glass: White Opalescent (WO)
 Finish: Raw Copper (RC)



CB-15TCR-BZ

Frame: CB-15
 Overlay: T-bar (T)
 Glass: Cream (CR)
 Finish: Bronze (BZ)

Overlay Design Options

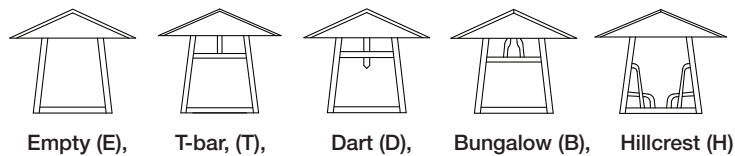

Specifications

Frame	Width	Height	Depth	Mounting Base	Mounting Center to Top	Lamping	C-UL Listing
CB-8	8"	10 3/8"	10 5/8"	4" x 8"	4 1/8"	1-100W, Medium	Incand. Damp
CB-12	12"	14 3/8"	15 1/2"	4 1/2" x 9"	5 1/16"	1-100W, Medium	Incand. Damp
CB-15	15"	19 1/8"	19"	5" x 11"	6 13/16"	1-100W, Medium	Incand. Damp



CH-8EF-BK
 Frame: CH-8
 Overlay: Empty (E)
 Glass: Frosted (F)
 Finish: Satin Black (BK)



CH-12HCR-RC
 Frame: CH-12
 Overlay: Hillcrest (H)
 Glass: Cream (CR)
 Finish: Raw Copper (RC)



CH-15DTN-BZ
 Frame: CH-15
 Overlay: Dart (D)
 Glass: Tan (TN)
 Finish: Bronze (BZ)

CSH-8TF-VP
 Frame: CSH-8
 Overlay: T-bar (T)
 Glass: Frosted (F)
 Finish: Verdigris Patina (VP)

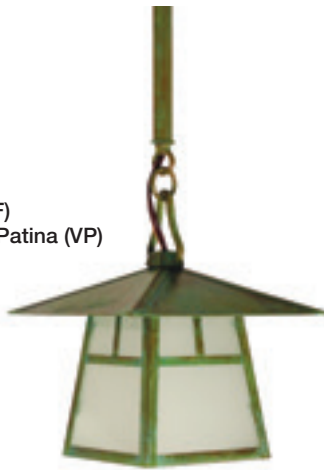

CSH-12TF-VP
 Frame: CSH-12
 Overlay: T-bar (T)
 Glass: Frosted (F)
 Finish: Verdigris Patina (VP)

Overlay Design Options

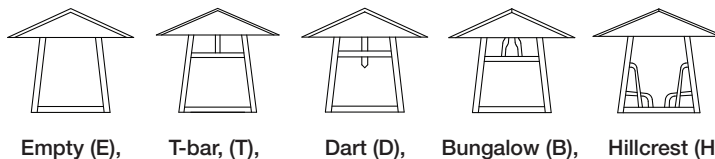

Specifications

Frame	Width	Height	Extension	Mounting Base	Lamping	C-UL Listing
CH-8	8"	9"	45"	4 ¼" sq.	1-100W, Medium	Incand. Damp
CH-12	12"	12 ⅝"	48 ⅝"	4 ¼" sq.	1-100W, Medium	Incand. Damp
CH-15	15"	16 ⅞"	52 ⅞"	4 ¼" sq.	1-100W, Medium	Incand. Damp
CSH-8	8"	9"	37 ⅞"	4 ¼" sq.	1-100W, Medium	Incand. Damp
CSH-12	12"	12 ⅝"	41 ½"	4 ¼" sq.	1-100W, Medium	Incand. Damp

PENDANT MOUNTING BASE



CICH-8/3BGW-AC

Frame: CICH-8/3
 Overlay: Bungalow (B)
 Glass: Gold White Iridescent (GW)
 Finish: Antique Copper (AC)



CCH-8/4BGW-VP

Frame: CCH-8/4
 Overlay: Bungalow (B)
 Glass: Gold White Iridescent (GW)
 Finish: Verdigris Patina (VP)

Overlay Design Options

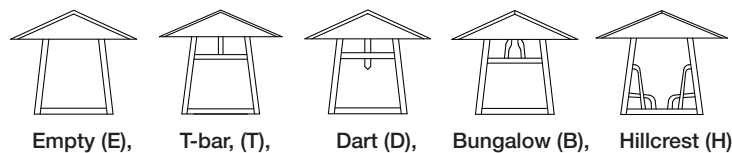

Specifications

Frame	Body Width	Overall Width	Height	Extension	Mounting Base	Lamping	C-UL Listing
CCH-8/4	8"	26 1/2"	25 5/8"	61 5/8"	4 1/4" sq.	4-60W, Medium	Incand. Dry
CICH-8/3	8"	36"	9"	37 7/8"	6" x 36"	3-60W, Medium	Incand. Dry



CC-8BTN-BZ
 Frame: CC-8
 Overlay: Bungalow (B)
 Glass: Tan (TN)
 Finish: Bronze (BZ)

CC-12TWO-VP
 Frame: CC-12
 Overlay: T-bar (T)
 Glass: White Opalescent (WO)
 Finish: Verdigris Patina (VP)



CC-15TWO-RC
 Frame: CC-15
 Overlay: T-bar (T)
 Glass: White Opalescent (WO)
 Finish: Raw Copper (RC)

Overlay Design Options

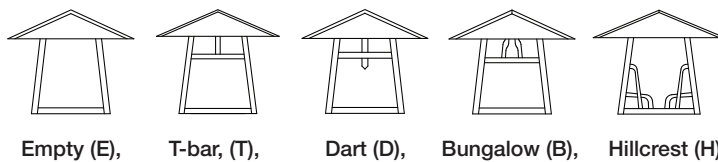

Specifications

Frame	Width	Height	Mounting Base	Lamping	C-UL Listing
CC-8	8"	7 ½"	6 ¼" sq.	1-60W, A19	Incand. Wet
CC-12	12"	10 ¼"	9 ¼" sq.	1-100W, A19	Incand. Wet
CC-15	15"	12 ⅜"	11 ⅛" sq.	1-100W, A19	Incand. Wet



CP-8BGW-VP

Frame: CP-8
 Overlay: Bungalow (B)
 Glass: Gold White Iridescent (GW)
 Finish: Verdigris Patina (VP)



CP-12BGW-RC

Frame: CP-12
 Overlay: Bungalow (B)
 Glass: Gold White Iridescent (GW)
 Finish: Raw Copper (RC)



CSP-8HWO-BZ

Frame: CSP-8
 Overlay: Hillcrest (H)
 Glass: White Opalescent (WO)
 Finish: Bronze (BZ)

CP-15TGW-BZ

Frame: CP-15
 Overlay: T-bar (T)
 Glass: Gold White Iridescent (GW)
 Finish: Bronze (BZ)



Overlay Design Options

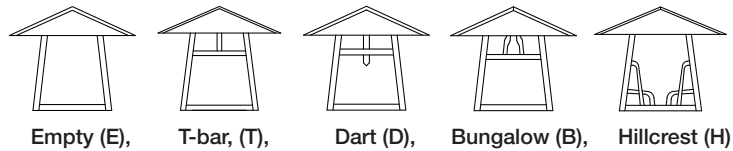

Specifications

Frame	Width	Height	Lamping	C-UL Listing
CP-8	8"	6 ½"	1-60W, A19	Incand. Wet
CP-12	12"	9 ¼"	1-100W, A19	Incand. Wet
CP-15	15"	11 ⅜"	1-100W, A19	Incand. Wet
CSP-8	8"	17 ⅝"	1-60W, A19	Incand. Wet



CRB-8CLR-BK
 Frame: CRB-8
 Glass: Clear (CLR)
 Finish: Satin Black (BK)

CRB-10CLR-BK
 Frame: CRB-10
 Glass: Clear (CLR)
 Finish: Satin Black (BK)



CRH-8CS-P
 Frame: CRH-8
 Glass: Clear Seedy (CS)
 Finish: Pewter (P)



CRH-10CLR-AB
 Frame: CRH-10
 Glass: Clear (CLR)
 Finish: Antique Brass (AB)

Specifications

Frame	Width	Height	Depth	Ext.	Mounting Base	Mounting Center to Top	Lamping	C-UL Rating
CRB-8	8"	16"	9"		4" x 7 1/2"	6"	3-60W, Candle Clear	Incand. Wet
CRB-10	10"	20 1/2"	10 1/2"		5" x 7 1/2"	8"	3-60W, Candle Clear	Incand. Wet
CRH-8	8"	17 1/2"		53 1/2"	4 1/4" sq.		3-60W, Candle Clear	Incand. Damp
CRH-10	10"	22"		58"	4 1/4" sq.		3-60W, Candle Clear	Incand. Damp



CRC-10RM-MB
 Frame: CRC-10
 Glass: Rain Mist (RM)
 Finish: Mission Brown (MB)



CRC-8CLR-BK
 Frame: CRC-8
 Glass: Clear (CLR)
 Finish: Satin Black (BK)



CRP-8CS-BZ
 Frame: CRP-8
 Glass: Clear Seedy (CS)
 Finish: Bronze (BZ)

CRP-10CLR-P
 Frame: CRP-10
 Glass: Clear (CLR)
 Finish: Pewter (P)



Specifications

Frame	Width	Height	Mounting Base	Lamping	C-UL Rating
CRC-8	8"	17 ½"	6" sq.	3-60W, Candle Clear	Incand. Wet
CRC-10	10"	21"	8" sq.	3-60W, Candle Clear	Incand. Wet
CRP-8	8"	16 ½"		3-60W, Candle Clear	Incand. Wet
CRP-10	10"	20 ½"		3-60W, Candle Clear	Incand. Wet





DS-4OF-MB

Frame: DS-4
 Glass: Off White (OF)
 Finish: Mission Brown (MB)



DS-6TN-RC

Frame: DS-6
 Glass: Tan (TN)
 Finish: Raw Copper (RC)



DS-8GW-VP

Frame: DS-8
 Glass: Gold White Iridescent (GW)
 Finish: Verdigris Patina (VP)

Specifications

Frame	Width	Height	Depth	Mounting Base	Mounting Center to Top	Lamping	C-UL Rating
DS-4	5"	11 ¼"	6 ¼"	5" sq.	2 ½"	1-60W, A15	Incand. Wet
DS-6	7 ½"	16 ¾"	9"	4" x 8 ½"	4 ¼"	1-100W, Medium	Incand. Wet
DS-8	10 ⅛"	22 ⅝"	11 ¾"	6" x 15"	7 ½"	1-100W, Medium	Incand. Wet



DH-4CR-AC
 Frame: DH-4
 Glass: Cream (CR)
 Finish: Antique Copper (AC)



DH-6RM-BZ
 Frame: DH-6
 Glass: Rain Mist (RM)
 Finish: Bronze (BZ)



DH-8WO-BK
 Frame: DH-8
 Glass: White Opalescent (WO)
 Finish: Satin Black (BK)

Specifications

Frame	Width	Height	Extension	Mounting Base	Lamping	C-UL Rating
DH-4	5"	11 5/8"	49 3/4"	5" sq.	1-60W, A15	Incand. Damp
DH-6	7 1/2"	17"	55"	5" sq.	1-100W, Medium	Incand. Damp
DH-8	10 1/8"	22 1/2"	59 3/4"	5" sq.	1-100W, Medium	Incand. Damp

Devonshire

Wall Mounts & Pendants



DEB-6CS-RC
 Frame: DEB-6
 Glass: Clear Seedy (CS)
 Finish: Raw Copper (RC)



DEB-8CLR-BZ
 Frame: DEB-8
 Glass: Clear (CLR)
 Finish: Bronze (BZ)



DEB-10CLR-BK
 Frame: DEB-10
 Glass: Clear (CLR)
 Finish: Satin Black (BK)



DEH-13CS-P
 Frame: DEH-13
 Glass: Clear Seedy (CS)
 Finish: Pewter (P)



DEH-17CLR-BK
 Frame: DEH-17
 Glass: Clear (CLR)
 Finish: Satin Black (BK)

Specifications

Frame	Width	Height	Depth	Extension	Mounting Base	Mounting Center to Top	Lamping	C-UL Rating
DEB-6	6"	10"	7"		4" x 5"	2 1/2"	1-100W, Medium	Incand. Wet
DEB-8	8"	16 1/2"	10"		5" x 8"	4"	2-60W, Candle Clear	Incand. Wet
DEB-10	10"	21"	12"		5" x 10"	5"	2-60W, Candle Clear	Incand. Wet
DEH-13	12 1/2"	18 1/2"		54 1/2"	4 1/4" sq.		4-60W, Candle Clear	Incand. Damp
DEH-17	17"	24 1/2"		60 1/2"	4 1/4" sq.		4-60W, Candle Clear	Incand. Damp



ETB-9GWC-BZ

Frame: ETB-9
 Glass: Gold White Iridescent & White Opalescent (GWC)
 Finish: Bronze (BZ)



ETB-11GWC-BZ

Frame: ETB-11
 Glass: Gold White Iridescent & White Opalescent (GWC)
 Finish: Bronze (BZ)



ETB-14GWC-BZ

Frame: ETB-14
 Glass: Gold White Iridescent & White Opalescent (GWC)
 Finish: Bronze (BZ)

Specifications

Frame	Width	Height	Depth	Mounting Base	Mounting Center to Top	Lamping	C-UL Rating
ETB-9	8 ½"	11"	9"	4 ¼" x 6 ¼"	3 ⅛"	1-100W, Medium	Incand. Wet
ETB-11	10 ⅞"	14 ⅝"	10 ⅞"	4 ¼" x 8 ¼"	4 ⅞"	1-100W, Medium	Incand. Wet
ETB-14	14 ¼"	17 ⅞"	13 ¾"	5" x 11"	5 ½"	1-100W, Medium	Incand. Wet



ETC-9GWC-RC

Frame: ETC-9
 Glass: Gold White Iridescent &
 White Opalescent (GWC)
 Finish: Raw Copper (RC)



ETC-11GWC-RC

Frame: ETC-11
 Glass: Gold White Iridescent &
 White Opalescent (GWC)
 Finish: Raw Copper (RC)



ETP-11GWC-VP

Frame: ETP-11
 Glass: Gold White Iridescent &
 White Opalescent (GWC)
 Finish: Verdigris Patina (VP)

Specifications

Frame	Width	Height	Mounting Base	Lamping	C-UL Rating
ETC-9	8 1/2"	10 5/8"	6 7/8"	1-60W, Medium	Incand. Wet
ETC-11	10 7/8"	13 1/2"	9"	1-100W, Medium	Incand. Wet
ETP-11	10 7/8"	15 1/2"		1-100W, Medium	Incand. Wet



ETH-9GWC-BZ

Frame: ETH-9
 Glass: Gold White Iridescent & White Opalescent (GWC)
 Finish: Bronze (BZ)



ETH-11GWC-BZ

Frame: ETH-11
 Glass: Gold White Iridescent & White Opalescent (GWC)
 Finish: Bronze (BZ)



ETH-14GWC-BZ

Frame: ETH-14
 Glass: Gold White Iridescent & White Opalescent (GWC)
 Finish: Bronze (BZ)



ETCH-21GWC-AB

Frame: ETCH-21
 Glass: Gold White Iridescent & White Opalescent (GWC)
 Finish: Antique Brass (AB)



ETCM-21GWC-AB

Frame: ETCH-21
 Glass: Gold White Iridescent & White Opalescent (GWC)
 Finish: Antique Brass (AB)

Specifications

Frame	Width	Height	Extension	Mounting Base	Lamping	C-UL Rating
ETH-9	8 ½"	11"	47"	4 ¼" sq.	1-100W, Medium	Incand. Damp
ETH-11	10 ⅞"	14 ⅝"	50 ⅝"	4 ¼" sq.	1-100W, Medium	Incand. Damp
ETH-14	14 ¼"	17 ½"	53 ½"	4 ¼" sq.	1-100W, Medium	Incand. Damp
ETCH-21	21"	25"	61"	4 ¼" sq.	4-100W, Medium	Incand. Dry
ETCM-21	21"	12"		4 ¼" sq.	4-100W, Medium	Incand. Dry

Evergreen

A subtle blend of Swiss Chalet, English Tudor and California Mission styles are skillfully married in this series with five choices of filigrees and decorative overlays.





EB-7AGW-VP
 Frame: EB-7
 Overlay: Classic Arch (A)
 Glass: Gold White Iridescent (GW)
 Finish: Verdigris Patina (VP)



EB-9TWO-RC
 Frame: EB-9
 Overlay: T-bar (T)
 Glass: White Opalescent (WO)
 Finish: Raw Copper (RC)



EB-16TOF-MB
 Frame: EB-16
 Overlay: T-bar (T)
 Glass: Off White (OF)
 Finish: Mission Brown (MB)



EB-12ACS-BZ
 Frame: EB-12
 Overlay: Classic Arch (A)
 Glass: Clear Seedy (CS)
 Finish: Bronze (BZ)

Ornamentation Options

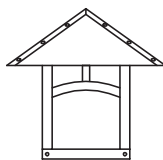

Classic Arch (A)

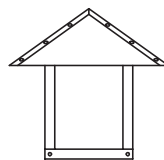

Empty (E)



Hummingbird Filigree (HF)



Pine Needle Filigree (PF)



Sycamore Filigree (SF)



T-bar (T)

Specifications

Frame	Width	Height	Depth	Mounting Base	Mounting Center to Top	Lamping	C-UL Rating
EB-7	7"	10 1/2"	8 3/4"	4" x 8"	4 1/4"	1-100W, Medium	Incand. Damp
EB-9	9"	12 7/8"	11 3/4"	4 1/2" x 9"	5 1/8"	1-100W, Medium	Incand. Damp
EB-12	12"	15 1/8"	14 3/8"	5" x 11"	7 1/8"	1-100W, Medium	Incand. Damp
EB-16	16"	19 1/2"	19 1/2"	5" x 11"	6 13/16"	1-100W, Medium	Incand. Damp



EW-7AWO-BZ
 Frame: EW-7
 Overlay: Classic Arch (A)
 Glass: White Opalescent (WO)
 Finish: Bronze (BZ)



EW-12PFGW-VP
 Frame: EW-12
 Overlay: Pine Needle Filigree (PF)
 Glass: Gold White Iridescent (GW)
 Finish: Verdigris Patina (VP)



EW-9HFGW-BZ
 Frame: EW-9
 Overlay: Hummingbird Filigree (HF)
 Glass: Gold White Iridescent (GW)
 Finish: Bronze (BZ)



EW-16PFGW-VP
 Frame: EW-16
 Overlay: Pine Needle Filigree (PF)
 Glass: Gold White Iridescent (GW)
 Finish: Verdigris Patina (VP)

Ornamentation Options

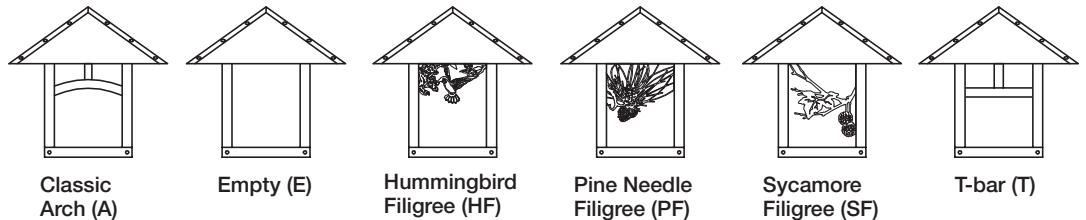

Specifications

Frame	Width	Height	Depth	Mounting Center to Top	Lamping	C-UL Rating
EW-7	7"	7 3/4"	4 1/2"	4"	1-60W, Candle	Incand. Wet
EW-9	9 1/8"	10 3/4"	6"	6 1/8"	1-100W, Medium	Incand. Wet
EW-12	11 1/4"	13"	7 3/8"	8"	1-100W, Medium	Incand. Wet
EW-16	16"	16 7/8"	10 3/8"	9 3/8"	1-100W, Medium	Incand. Wet



EH-7AF-BZ
 Frame: EH-7
 Overlay: Classic Arch (A)
 Glass: Frosted (F)
 Finish: Bronze (BZ)



EH-9SFOF-VP
 Frame: EH-9
 Overlay: Sycamore Filigree (SF)
 Glass: Off White (OF)
 Finish: Verdigris Patina (VP)



EH-12HFTN-MB
 Frame: EH-12
 Overlay: Hummingbird Filigree (HF)
 Glass: Tan (TN)
 Finish: Mission Brown (MB)



EH-16PFOF-RC
 Frame: EH-16
 Overlay: Pine Needle Filigree (PF)
 Glass: Off White (OF)
 Finish: Raw Copper (RC)

Specifications

Frame	Width	Height	Extension	Mounting Base	Lamping	C-UL Rating
EH-7	7"	9 1/2"	45 1/2"	4 1/4" sq.	1-100W, Medium	Incand. Damp
EH-9	9"	11 3/4"	47 3/4"	4 1/4" sq.	1-100W, Medium	Incand. Damp
EH-12	12"	13 5/8"	49 5/8"	4 1/4" sq.	1-100W, Medium	Incand. Damp
EH-16	16"	17 1/4"	53 1/4"	4 1/4" sq.	1-100W, Medium	Incand. Damp

PENDANT MOUNTING BASE





ESH-7AGW-VP

Frame: ESH-7
 Overlay: Classic Arch (A)
 Glass: Gold White Iridescent (GW)
 Finish: Verdigris Patina (VP)

ESH-9PFF-BZ

Frame: ESH-9
 Overlay: Pine Needle Filigree (PF)
 Glass: Frosted (F)
 Finish: Bronze (BZ)



ESH-12PFF-BZ

Frame: ESH-12
 Overlay: Pine Needle Filigree (PF)
 Glass: Frosted (F)
 Finish: Bronze (BZ)

Ornamentation Options

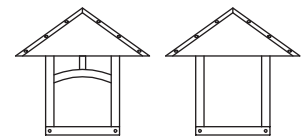

Classic Arch (A) Empty (E)

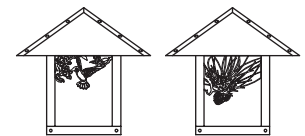

Hummingbird Filigree (HF) Pine Needle Filigree (PF)

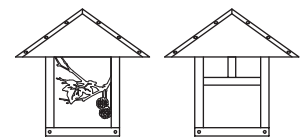

Sycamore Filigree (SF) T-bar (T)

Specifications

Frame	Width	Height	Extension	Mounting Base	Lamping	C-UL Rating
ESH-7	7"	9 1/2"	38 1/2"	4 1/4" sq.	1-100W, Medium	Incand. Damp
ESH-9	9"	11 3/4"	41"	4 1/4" sq.	1-100W, Medium	Incand. Damp
ESH-12	12"	13 5/8"	42 3/4"	4 1/4" sq.	1-100W, Medium	Incand. Damp

MOUNTING BASE





EC-9AGW-VP
 Frame: EC-9
 Overlay: Classic Arch (A)
 Glass: Gold White Iridescent (GW)
 Finish: Verdigris Patina (VP)



EC-12TWO-BK
 Frame: EC-12
 Overlay: T-bar (T)
 Glass: White Opalescent (WO)
 Finish: Satin Black (BK)



EC-16AGW-BZ
 Frame: EC-16
 Overlay: Classic Arch (A)
 Glass: Gold White Iridescent (GW)
 Finish: Bronze (BZ)

Ornamentation Options



Specifications

Frame	Width	Height	Mounting Base	Lamping	C-UL Rating
EC-9	9"	10 3/4"	7" sq.	1-100W, A19	Incand. Wet
EC-12	12"	12 3/4"	8 1/8" sq.	1-100W, A19	Incand. Wet
EC-16	16"	16 1/4"	9 3/8" sq.	1-100W, A19	Incand. Wet



EP-7AF-RB
 Frame: EP-7
 Overlay: Classic Arch (A)
 Glass: Frosted (F)
 Finish: Rustic Brown (RB)



EP-9TF-RB
 Frame: EP-9
 Overlay: T-bar (T)
 Glass: Frosted (F)
 Finish: Rustic Brown (RB)



EP-12HFF-RB
 Frame: EP-12
 Overlay: Hummingbird Filigree (HF)
 Glass: Frosted (F)
 Finish: Rustic Brown (RB)



ESP-7SFGW-RC
 Frame: ESP-7
 Overlay: Sycamore Filigree (SF)
 Glass: Gold White Iridescent (GW)
 Finish: Raw Copper (RC)



ESP-9PFGW-RC
 Frame: ESP-9
 Overlay: Pine Needle Filigree (PF)
 Glass: Gold White Iridescent (GW)
 Finish: Raw Copper (RC)



EP-16AFL-RC
 Frame: EP-16
 Overlay: Classic Arch (A)
 Glass: Flemish (FL)
 Finish: Raw Copper (RC)

Ornamentation Options

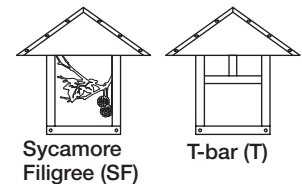
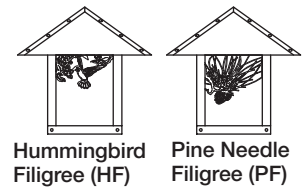
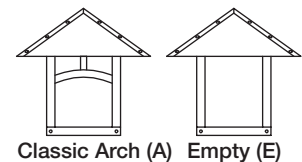

Specifications

Frame	Width	Height	Lamping	C-UL Rating
EP-7	7"	7 3/4"	1-60W, A19	Incand. Wet
EP-9	9"	9 3/4"	1-100W, A19	Incand. Wet
EP-12	12"	12"	1-100W, A19	Incand. Wet
EP-16	16"	15 1/8"	1-100W, A19	Incand. Wet
ESP-7	7"	19 1/2"	1-60W, A19	Incand. Wet
ESP-9	9"	21 1/2"	1-100W, A19	Incand. Wet

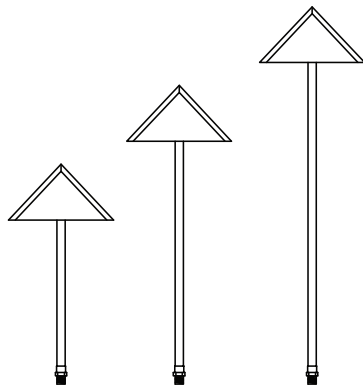

LV12-8R LV18-8R LV24-8R

LV24-8RWO-RB

Frame: LV24-8R
 Glass: White Opalescent
 Glass Jewels (WO)
 Finish: Rustic Brown (RB)



Specifications

Frame	Width	Height	Lamping	C-UL Rating
LV12-8R	8"	16"	1-18W, Low Voltage T-5 Wedge	Incand. Wet
LV18-8R	8"	22"	1-18W, Low Voltage T-5 Wedge	Incand. Wet
LV24-8R	8"	28"	1-18W, Low Voltage T-5 Wedge	Incand. Wet

Mail Boxes



EMBL-RB
 Frame: EMBL
 Finish: Rustic Brown (RB)



EMB-BZ
 Frame: EMB
 Finish: Bronze (BZ)

Specifications

Frame	Width	Height	Depth
EMB	9 1/2"	12"	4 5/8"
EMBL	18"	8 7/8"	4 1/2"



EXS-9CLR-BZ
 Frame: EXS-9
 Glass: Clear (CLR)
 Finish: Bronze (BZ)

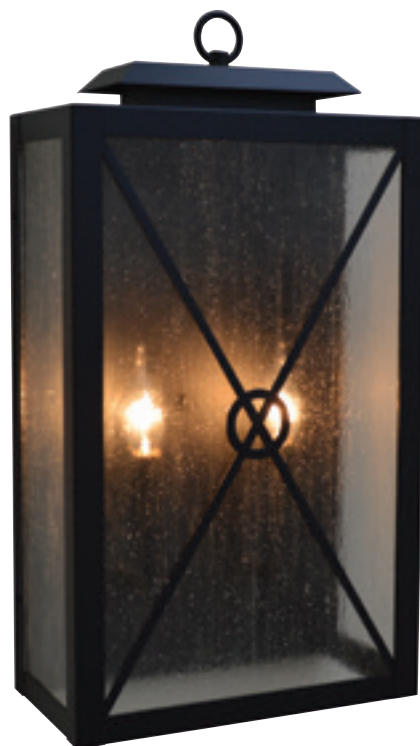

EXS-12CS-BK
 Frame: EXS-12
 Glass: Clear Seedy (CS)
 Finish: Satin Black (BK)



EXS-6CS-BK
 Frame: EXS-6
 Glass: Clear Seedy (CS)
 Finish: Satin Black (BK)

Specifications

Frame	Width	Height	Depth	Mounting Center to Top	Lamping	C-UL Rating
EXS-6	5 ½"	10 ½"	4"	6 ⅝"	1-60W, Candle Clear	Incand. Wet
EXS-9	9"	16"	5"	9 ½"	2-60W, Candle Clear	Incand. Wet
EXS-12	11 ½"	22"	6"	13"	2-60W, Candle Clear	Incand. Wet

EXH-9RM-RC

Frame: EXH-9
 Glass: Rain Mist (RM)
 Finish: Raw Copper (RC)



EXC-9DD-RC

Frame: EXC-9
 Glass: Dew Drop (DD)
 Finish: Raw Copper (RC)

EXP-9F-MB

Frame: EXP-9
 Glass: Frosted (F)
 Finish: Mission Brown (MB)



Specifications

Frame	Width	Height	Extension	Mounting Base	Lamping	C-UL Rating
EXC-9	9"	16 ½"		10 ½" sq.	2-60W, Candle Clear	Incand. Wet
EXH-9	9"	15 ½"	50 ½"	4 ¼"	2-60W, Candle Clear	Incand. Damp
EXP-9	9"	15 ½"			2-60W, Candle Clear	Incand. Wet





FIW-8TN-MB
 Frame: FIW-8
 Glass: Tan (TN)
 Finish: Mission Brown (MB)



FIW-8LF-BZ
 Frame: FIW-8L
 Glass: Frosted (F)
 Finish: Bronze (BZ)



FIW-10TN-MB
 Frame: FIW-10
 Glass: Tan (TN)
 Finish: Mission Brown (MB)



FIW-10LCR-VP
 Frame: FIW-10L
 Glass: Cream (CR)
 Finish: Verdigris Patina (VP)

Specifications

Frame	Width	Height	Depth	Mounting Base	Mounting Center to Top	Lamping	C-UL Rating
FIW-8	8"	8 ½"	7"	4 ½" x 5 ¾"	2 ⅞"	1-72W, Medium	Incand. Wet
FIW-8L	8"	10 ½"	7"	4 ½" x 5 ¾"	2 ⅞"	1-72W, Medium	Incand. Wet
FIW-10	10"	12"	9"	5 ½" x 7"	3 ½"	1-72W, Medium	Incand. Wet
FIW-10L	10"	14 ½"	9"	5 ½" x 7"	3 ½"	1-72W, Medium	Incand. Wet

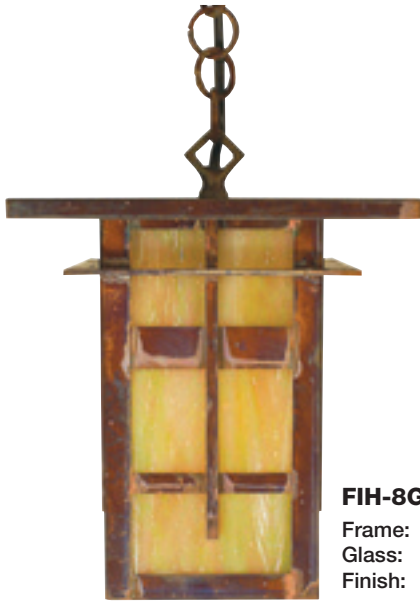

FIH-8GW-RC
 Frame: FIH-8
 Glass: Gold White Iridescent (GW)
 Finish: Raw Copper (RC)



FIH-8LTN-MB
 Frame: FIH-8L
 Glass: Tan (TN)
 Finish: Mission Brown (MB)



FIH-10GW-RC
 Frame: FIH-10
 Glass: Gold White Iridescent (GW)
 Finish: Raw Copper (RC)



FIH-10LTN-MB
 Frame: FIH-10L
 Glass: Tan (TN)
 Finish: Mission Brown (MB)

Specifications

Frame	Width	Height	Ext.	Mounting Base	Lamping	C-UL Rating
FIH-8	8"	10"	46"	4 ¼" sq.	1-72W, Medium	Incand. Damp
FIH-8L	8"	12"	48"	4 ¼" sq.	1-72W, Medium	Incand. Damp
FIH-10	10"	13 ½"	49 ½"	4 ¼" sq.	1-72W, Medium	Incand. Damp
FIH-10L	10"	16 ½"	52 ½"	4 ¼" sq.	1-72W, Medium	Incand. Damp



FIC-12CR-RC
 Frame: FIC-12
 Glass: Cream (CR)
 Finish: Raw Copper (RC)



FIC-16WO-VP
 Frame: FIC-16
 Glass: White Opalescent (WO)
 Finish: Verdigris Patina (VP)



FIC-20CS-BZ
 Frame: FIC-20
 Glass: Clear Seedy (CS)
 Finish: Bronze (BZ)

Specifications

Frame	Width	Height	Mounting Base	Lamping	C-UL Rating
FIC-12	12"	5"	11" sq.	1-72W, Medium	Incand. Wet
FIC-16	16"	7"	14" sq.	1-72W, Medium	Incand. Wet
FIC-20	20"	8 ½"	18" sq.	1-72W, Medium	Incand. Wet



FIP-8WO-BK
 Frame: FIP-8
 Glass: White Opalescent (WO)
 Finish: Satin Black (BK)

FIP-8LDD-BK
 Frame: FIP-8L
 Glass: Dew Drop (DD)
 Finish: Satin Black (BK)

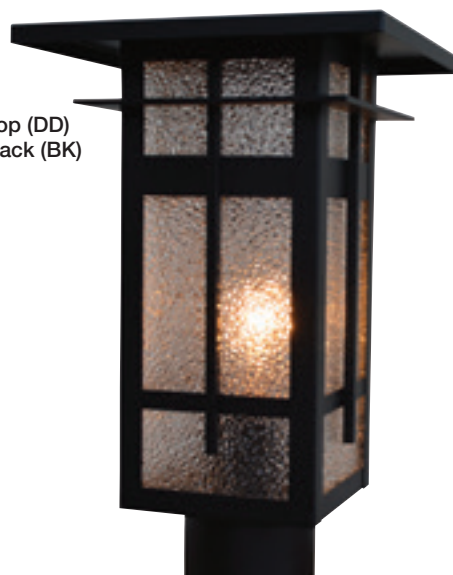

FIP-10WO-BK
 Frame: FIP-10
 Glass: White Opalescent (WO)
 Finish: Satin Black (BK)



FIP-10LGW-BZ
 Frame: FIP-10L
 Glass: Gold White Iridescent (GW)
 Finish: Bronze (BZ)

Specifications

Frame	Width	Height	Lamping	C-UL Rating
FIP-8	8"	8 ½"	1-72W, Medium	Incand. Wet
FIP-8L	8"	10 ½"	1-72W, Medium	Incand. Wet
FIP-10	10"	12"	1-72W, Medium	Incand. Wet
FIP-10L	10"	15"	1-72W, Medium	Incand. Wet



FB-9LG-MB
 Frame: FB-9L
 Glass: Green-Black (G)
 Finish: Mission Brown (MB)



FB-9LSAC-BK
 Frame: FB-9LSA
 Glass: Yellow-Green (C)
 Finish: Satin Black (BK)



FW-9LC-BZ
 Frame: FW-9L
 Glass: Yellow-Green (C)
 Finish: Bronze (BZ)



Specifications

Frame	Width	Height	Depth	Mounting Base	Mounting Center to Top	Lamping	C-UL Rating
FB-9L	9"	15 1/8"	11 3/4"	4 1/2" x 9"	5 1/4"	1-100W, Medium	Incand. Damp
FB-9LSA	9"	19 1/8"	11 1/8"	5" sq.	2 1/2"	1-100W, Medium	Incand. Damp
FW-9L	9"	12"	7"	4 1/4" x 6"	3 1/16"	1-100W, Medium	Incand. Damp

FCH-9L/4C-P

Frame: FCH-9L/4
 Glass: Yellow-Green (C)
 Finish: Pewter (P)



FICH-9L/3Y-BZ

Frame: FICH-9L/3
 Glass: Yellow-Black (Y)
 Finish: Bronze (BZ)



FH-9LG-BZ

Frame: FH-9L
 Glass: Green-Black (G)
 Finish: Bronze (BZ)



FSH-9LY-VP

Frame: FSH-9L
 Glass: Yellow-Black (Y)
 Finish: Verdigris Patina (VP)

Specifications

Frame	Roof Width	Overall Width	Height	Extension	Mounting Base	Lamping	C-UL Rating
FH-9L	9"		14"	50"	4 1/4" sq.	1-100W, Medium	Incand. Damp
FSH-9L	9"		12"	35 1/4"	4 1/4" sq.	1-100W, Medium	Incand. Damp
FCH-9L/4	9"	33 3/8"	34 5/8"	70 3/8"	6" sq.	4-60W, Medium	Incand. Dry
FICH-9L/3	37"		12"	45 1/8"	6" x 36"	3-60W, Medium	Incand. Damp

PENDANT MOUNTING BASE



Glasgow

Inspired by the designs of C. R. Mackintosh, these Japanese influenced fixtures are at once contemporary yet traditional.



photo credit: Kenny Goodman, AIA, CID, Trademark Architecture + Interiors



GB-6GWC-VP

Frame: GB-6
 Glass: Gold White Iridescent
 White Opalescent Combination (GWC)
 Finish: Verdigris Patina (VP)



GB-6LTN-RC

Frame: GB-6L
 Glass: Tan (TN)
 Finish: Raw Copper (RC)



GB-9GWC-VP

Frame: GB-9
 Glass: Gold White Iridescent
 White Opalescent Combination (GWC)
 Finish: Verdigris Patina (VP)



GB-18GWC-VP

Frame: GB-18
 Glass: Gold White Iridescent
 White Opalescent Combination (GWC)
 Finish: Verdigris Patina (VP)



GB-9LWO-BK

Frame: GB-9L
 Glass: White Opalescent (WO)
 Finish: Satin Black (BK)

GB-18LWO-BK

Frame: GB-18L
 Glass: White Opalescent (WO)
 Finish: Satin Black (BK)

Specifications

Frame	Width	Height	Depth	Mounting Base	Mounting Center to Top	Lamping	C-UL Rating
GB-6	6"	8 ¼"	8 ¼"	4" x 6"	4 ¾"	1-60W, A15	Incand. Damp
GB-6L	6"	9 ¾"	8 ¼"	4" x 6"	4 ¾"	1-60W, Medium	Incand. Damp
GB-9	9"	12 ⅞"	11 ¾"	4 ½" x 9"	5 ⅞"	1-100W, Medium	Incand. Damp
GB-9L	9"	15 ⅞"	11 ¾"	4 ½" x 9"	5 ⅞"	1-100W, Medium	Incand. Damp
GB-18	18"	24"	20 ⅝"	6" x 15"	6 ½"	1-150W, Medium	Incand. Damp
GB-18L	18"	30"	20 ⅝"	6" x 15"	6 ¾"	1-150W, Medium	Incand. Damp

GB-6LSAGW-RC

Frame: GB-6LSA
 Glass: Gold White Iridescent (GW)
 Finish: Raw Copper (RC)



GB-6SAGW-RC

Frame: GB-6S
 Glass: Gold White Iridescent (GW)
 Finish: Raw Copper (RC)



GB-9SAGWC-BZ

Frame: GB-9S
 Glass: Gold White Iridescent
 White Opalescent Combination (GWC)
 Finish: Bronze (BZ)



GB-9LSAGWC-BZ

Frame: GB-9LSA
 Glass: Gold White Iridescent
 White Opalescent Combination (GWC)
 Finish: Bronze (BZ)

Specifications

Frame	Width	Height	Depth	Mounting Base	Mounting Center to Top	Lamping	C-UL Rating
GB-6SA	6"	12 1/8"	8 3/8"	5" sq.	2 1/2"	1-60W, Medium	Incand. Damp
GB-6LSA	6"	13 5/8"	8 3/8"	5" sq.	2 1/2"	1-60W, Medium	Incand. Damp
GB-9SA	9"	16 1/8"	11 1/8"	5" sq.	2 1/2"	1-100W, Medium	Incand. Damp
GB-9LSA	9"	19 1/8"	11 1/8"	5" sq.	2 1/2"	1-100W, Medium	Incand. Damp



GS-9LWO-BZ

Frame: GS-9L
Glass: White Opalescent (WO)
Finish: Bronze (BZ)



GS-9WO-BZ

Frame: GS-9
Glass: White Opalescent (WO)
Finish: Bronze (BZ)



GSADA-9GW-AC

Frame: GSADA-9
Glass: Gold White Iridescent (GW)
Finish: Antique Copper (AC)



GSADA-12GWC-AB

Frame: GSADA-12
Glass: Gold White Iridescent
White Opalescent Combination (GWC)
Finish: Antique Brass (AB)

Specifications

Frame	Width	Height	Depth	Mounting Center to Top	Lamping	C-UL Rating
GS-9	4 ¾"	9"	5 ¼"	4 ½"	1-100W, Medium	Incand. Dry
GS-9L	4 ¾"	12"	5 ¼"	6"	1-100W, Medium	Incand. Dry
GSADA-9	6 ½"	9"	4"	4 ½"	1-60W, T10	Incand. Dry
GSADA-12	6 ½"	12"	4"	6"	1-60W, T10	Incand. Dry

Glasgow

Wall Mounts



GW-9CR-RB
 Frame: GW-9
 Glass: Cream (CR)
 Finish: Rustic Brown (RB)



GW-9LGWC-VP
 Frame: GW-9L
 Glass: Gold White Iridescent
 White Opalescent Combination (GWC)
 Finish: Verdigris Patina (VP)



GW-18CR-RB
 Frame: GW-18
 Glass: Cream (CR)
 Finish: Rustic Brown (RB)



GW-18LGW-MB
 Frame: GW-18L
 Glass: Gold White Iridescent (GW)
 Finish: Mission Brown (MB)

Specifications

Frame	Width	Height	Depth	Mounting Base	Mounting Center to Top	Lamping	C-UL Rating
GW-9	9"	9"	7"	4 ¼" x 6"	3"	1-100W, Medium	Incand. Wet
GW-9L	9"	12"	7"	4 ¼" x 6"	3"	1-100W, Medium	Incand. Wet
GW-18	18"	18"	14 ½"	8 ¾" x 12"	6"	2-100W, Medium	Incand. Wet
GW-18L	18"	24"	14 ½"	8 ¾" x 12"	6"	2-100W, Medium	Incand. Wet



GH-6F-BK

Frame: GH-6
Glass: Frosted (F)
Finish: Satin Black (BK)



GH-6LCR-RB

Frame: GH-6L
Glass: Cream (CR)
Finish: Rustic Brown (RB)



GH-9GW-MB

Frame: GH-9
Glass: Gold White Iridescent (GW)
Finish: Mission Brown (MB)



GH-9LWO-BK

Frame: GH-9L
Glass: White Opalescent(WO)
Finish: Satin Black (BK)



GH-18GWC-RC

Frame: GH-18
Glass: Gold White Iridescent
White Opalescent Combination (GWC)
Finish: Raw Copper (RC)



GH-18LBC-P

Frame: GH-18L
Glass: Blue-White Opalescent
Combination (BC)
Finish: Pewter (P)

Specifications

Frame	Width	Height	Extension	Mounting Base	Lamping	C-UL Rating
GH-6	6"	7 1/8"	43 1/8"	4 1/4" sq.	1-60W, Medium	Incand. Damp
GH-6L	6"	8 5/8"	44 5/8"	4 1/4" sq.	1-60W, Medium	Incand. Damp
GH-9	9"	11"	47"	4 1/4" sq.	1-100W, Medium	Incand. Damp
GH-9L	9"	14"	50"	4 1/4" sq.	1-100W, Medium	Incand. Damp
GH-18	18"	21 1/2"	57 1/2"	4 1/4" sq.	1-150W, Medium	Incand. Damp
GH-18L	18"	27 1/2"	63 1/2"	4 1/4" sq.	1-150W, Medium	Incand. Damp

PENDANT MOUNTING BASE





GSH-6LGWC-BZ

Frame: GSH-6L
 Glass: Gold White Iridescent
 White Opalescent
 Combination (GWC)
 Finish: Bronze (BZ)



GSH-9GWC-BZ

Frame: GSH-9
 Glass: Gold White Iridescent
 White Opalescent
 Combination (GWC)
 Finish: Bronze (BZ)



GSH-9LGWC-BZ

Frame: GSH-9L
 Glass: Gold White Iridescent
 White Opalescent
 Combination (GWC)
 Finish: Bronze (BZ)

Specifications

Frame	Width	Height	Extension	Mounting Base	Lamping	C-UL Rating
GSH-6L	6"	7"	38 ¾"	4 ¼" sq.	1-60W, Medium	Incand. Damp
GSH-9	9"	9"	42 ⅛"	4 ¼" sq.	1-100W, Medium	Incand. Damp
GSH-9L	9"	12"	45 ⅛"	4 ¼" sq.	1-100W, Medium	Incand. Damp

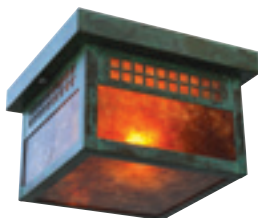

GCM-7M-VP
 Frame: GCM-7
 Glass: Amber Mica (M)
 Finish: Verdigris Patina (VP)

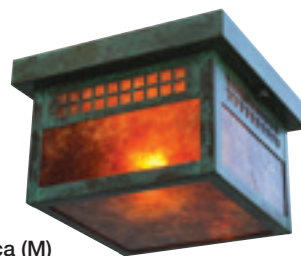

GCM-8M-VP
 Frame: GCM-8
 Glass: Amber Mica (M)
 Finish: Verdigris Patina (VP)



GCM-12GWC-RC
 Frame: GCM-12
 Glass: Gold White Iridescent-White
 Opalescent Combination (GWC)
 Finish: Raw Copper (RC)



GCM-18GWC-AC
 Frame: GCM-18
 Glass: Gold White Iridescent-White
 Opalescent Combination (GWC)
 Finish: Antique Copper (AC)

Specifications

Frame	Width	Height	Mounting Base	Lamping	C-UL Rating
GCM-7	7"	5 ¼"	8 ½" sq.	1-60W, Medium	Incand. Damp
GCM-8	8 ⅜"	6 ¼"	9 ¾" sq.	2-60W, Medium	Incand. Damp
GCM-12	12"	7 ¼"	13 ½" sq.	2-60W, Medium	Incand. Damp
GCM-18	12" x 18"	7 ¼"	13 ½" x 19 ⅝"	2-60W, Medium	Incand. Damp



GCH-9L/4-CR-BZ
 Frame: GCH-9L/4
 Glass: Cream (CR)
 Finish: Bronze (BZ)



GCH-9L/4-1M-BZ
 Frame: GCH-9L/4-1
 Glass: Amber Mica (M)
 Finish: Bronze (BZ)

Specifications

Frame	Width	Overall Width	Height	Extension	Mounting Base	Lamping	C-UL Rating
GCH-9L/4	9"	33 ⅜"	34 ⅝"	70 ⅝"	6" sq.	4-60W, Medium	Incand. Dry
GCH-9L/4-1	9"	33 ⅜"	36"	72"	6" sq.	5-60W, Medium	Incand. Dry



GC-9RM-VP
 Frame: GC-9
 Glass: Rain Mist (RM)
 Finish: Verdigris Patina (VP)



GC-9LFL-BZ
 Frame: GC-9L
 Glass: Flemish (FL)
 Finish: Bronze (BZ)



GC-18GWC-BZ
 Frame: GC-18
 Glass: Gold White Iridescent-
 White Opalescent Combination (GWC)
 Finish: Bronze (BZ)



GC-18LGWC-BZ
 Frame: GC-18L
 Glass: Gold White Iridescent-White
 Opalescent Combination (GWC)
 Finish: Bronze (BZ)

Specifications

Frame	Width	Height	Mounting Base	Lamping	C-UL Rating
GC-9	9"	9 ¾"	6 ½" sq.	1-100W, A19	Incand. Wet
GC-9L	9"	12 ¾"	6 ½" sq.	1-100W, A19	Incand. Wet
GC-18	18"	19 ½"	13 ¼" sq.	1-150W, A19	Incand. Wet
GC-18L	18"	23 ½"	13 ¼" sq.	1-150W, A19	Incand. Wet



GSP-6GW-MB
 Frame: GSP-6
 Glass: Gold White Iridescent (GW)
 Finish: Mission Brown (MB)

GSP-6LGW-MB
 Frame: GSP-6L
 Glass: Gold White Iridescent (GW)
 Finish: Mission Brown (MB)

GP-9LWO-BK
 Frame: GP-9L
 Glass: White Opalescent (WO)
 Finish: Satin Black (BK)

GP-18GW-BZ
 Frame: GP-18
 Glass: Gold White Iridescent (GW)
 Finish: Bronze (BZ)

Specifications

Frame	Width	Height	Lamping	C-UL Rating
GP-9L	9"	12"	1-100W, A19	Incand. Wet
GP-18	18"	18"	1-150W, A19	Incand. Wet
GSP-6	6"	17 3/8"	1-60W, A19	Incand. Wet
GSP-6L	6"	19"	1-60W, A19	Incand. Wet

Mail Boxes

GMB-BK
 Frame: GMB
 Finish: Satin Black (BK)



Specifications

Frame	Width	Height	Depth
GMB	8 3/8"	12"	4 1/2"
GMBL	17"	8 1/2"	4 1/2"

GMBL-VP
 Frame: GMBL
 Finish: Verdigris Patina (VP)

Glencoe

The flat roof and strong straight lines of the Glencoe series is reminiscent of the Prairie Style homes built by Frank Lloyd Wright in the Ravine Bluffs neighborhood of Glencoe, IL.



GLB-6F-RB

Frame: GLB-6
 Glass: Frosted (F)
 Finish: Rustic Brown (RB)



GLB-9GW-MB

Frame: GLB-9
 Glass: Gold White Iridescent (GW)
 Finish: Mission Brown (MB)

Specifications

Frame	Width	Height	Depth	Mounting Base	Mounting Center to Top	Lamping	C-UL Rating
GLB-6	6"	11"	8"	4 ¼" x 5"	4 ¼"	1-100W, Medium	Incand. Wet
GLB-9	8 ½"	15"	11"	4 ¼" x 7"	5 ⅜"	1-100W, Medium	Incand. Wet



GLS-6WO-BZ

Frame: GLS-6
Glass: White Opalescent (WO)
Finish: Bronze (BZ)



GLS-9OF-RC

Frame: GLS-9
Glass: Off White (OF)
Finish: Raw Copper (RC)



GLC-16WO-BK

Frame: GLC-16
Glass: White Opalescent (WO)
Finish: Satin Black (BK)

Specifications

Frame	Width	Height	Depth	Mounting Base	Mounting Center to Top	Lamping	C-UL Rating
GLS-6	6"	11"	4 ¼"		5 ½"	1-100W, Medium	Incand. Dry
GLS-9	8 ½"	15"	6"		7 ½"	1-100W, Medium	Incand. Dry
GLC-16	16"	8"		16" sq.		2-100W, Medium	Incand. Wet



HAB-8GW-BZ
 Frame: HAB-8
 Glass: Gold White Iridescent (GW)
 Finish: Bronze (BZ)

HAB-5WO-P
 Frame: HAB-5
 Glass: White Opalescent (WO)
 Finish: Pewter (P)



HAB-6CS-MB
 Frame: HAB-6
 Glass: Clear Seedy (CS)
 Finish: Mission Brown (MB)

Specifications

Frame	Width	Height	Depth	Mounting Base	Mounting Center to Top	Lamping	C-UL Rating
HAB-5	5"	10 ½"	6"	4 ¼" sq.	8"	1-100W, Medium	Incand. Wet
HAB-6	6"	22 ½"	6"	5" x 8"	15 ¾"	2-60W, Candle Clear	Incand. Wet
HAB-8	8"	28 ½"	6"	5" x 10"	20"	2-60W, Candle Clear	Incand. Wet



HAH-5GW-BZ
 Frame: HAH-5
 Glass: Gold White Iridescent (GW)
 Finish: Bronze (BZ)



HAH-8DD-VP
 Frame: HAH-8
 Glass: Dew Drop (DD)
 Finish: Verdigris Patina (VP)



HAC-16CLR-MB
 Frame: HAC-16
 Glass: Clear (CLR)
 Finish: Mission Brown (MB)

Specifications

Frame	Width	Height	Ext.	Mounting Base	Lamping	C-UL Rating
HAH-5	5"	10 ½"	46 ½"	4 ¼" sq.	1-100W, Medium	Incand. Damp
HAH-8	8"	24"	60"	4 ¼" sq.	2-60W, Candle Clear	Incand. Damp
HAC-16	16"	11"		16" sq.	4-60W, Candle Clear	Incand. Wet



HW-8LGW-BZ

Frame: HW-8L
 Glass: Gold White Iridescent (GW)
 Finish: Bronze (BZ)



HW-8GW-BZ

Frame: HW-8
 Glass: Gold White Iridescent (GW)
 Finish: Bronze (BZ)



HW-6GW-BZ

Frame: HW-6
 Glass: Gold White Iridescent (GW)
 Finish: Bronze (BZ)

Specifications

Frame	Width	Height	Depth	Mounting Center to Top	Lamping	C-UL Rating
HW-6	6"	14"	4 ½"	10"	1-60W, A15	Incand. Wet
HW-8	8"	17 ½"	5 ½"	11 ½"	1-100W, Medium	Incand. Wet
HW-8L	8"	19 ½"	5 ½"	11 ½"	1-100W, Medium	Incand. Wet



HH-6CS-BZ

Frame: HH-6
Glass: Clear Seedy (CS)
Finish: Bronze (BZ)



HH-8CS-BZ

Frame: HH-8
Glass: Clear Seedy (CS)
Finish: Bronze (BZ)



HH-8LCS-BZ

Frame: HH-8L
Glass: Clear Seedy (CS)
Finish: Bronze (BZ)

Specifications

Frame	Width	Height	Extension	Mounting Base	Lamping	C-UL Rating
HH-6	6"	14 ½"	50 ½"	4 ¼" sq.	1-100W, Medium	Incand. Damp
HH-8	8"	18 ½"	54 ½"	4 ¼" sq.	1-100W, Medium	Incand. Damp
HH-8L	8"	20 ½"	56 ½"	4 ¼" sq.	1-100W, Medium	Incand. Damp



HC-8LWO-AB

Frame: HC-8L
 Glass: White Opalescent (WO)
 Finish: Antique Brass (AB)



HC-8WO-AB

Frame: HC-8
 Glass: White Opalescent (WO)
 Finish: Antique Brass (AB)



HC-6RM-BK

Frame: HC-6
 Glass: Rain Mist (RM)
 Finish: Satin Black (BK)

Specifications

Frame	Width	Height	Mounting Base	Lamping	C-UL Rating
HC-6	6"	15"	6" sq.	1-100W, Medium	Incand. Wet
HC-8	8"	18 ½"	8" sq.	1-100W, Medium	Incand. Wet
HC-8L	8"	20 ½"	8" sq.	1-100W, Medium	Incand. Wet



HP-6RM-RC

Frame: HP-6
Glass: Rain Mist (RM)
Finish: Raw Copper (RC)



HP-8LRM-RC

Frame: HP-8L
Glass: Rain Mist (RM)
Finish: Raw Copper (RC)



HP-8RM-RC

Frame: HP-8
Glass: Rain Mist (RM)
Finish: Raw Copper (RC)

Specifications

Frame	Width	Height	Lamping	C-UL Rating
HP-6	6"	16 ½"	1-100W, Medium	Incand. Wet
HP-8	8"	20 ¼"	1-100W, Medium	Incand. Wet
HP-8L	8"	22 ¼"	1-100W, Medium	Incand. Wet

Huntington

*Inspired by the early
Prairie School designs
of Frank Lloyd Wright,
this series features long
horizontal lines and
broad sheltering roofs.*





HB-4LDTGW-RC
 Frame: HB-4L
 Overlay: Double T-bar (DT)
 Glass: Gold White Iridescent (GW)
 Finish: Raw Copper (RC)



HB-4LWDTCR-RB
 Frame: HB-4LW
 Overlay: Double T-bar (DT)
 Glass: Cream (CR)
 Finish: Rustic Brown (RB)

Solid attachment
for wet locations

Specifications

Frame	Width	Height	Depth	Mounting Base	Mounting Center to Top	Lamping	C-UL Rating
*HB-4L	5"	8 3/4"	7 3/4"	4" x 6"	4 3/4"	1-60W, A15	Incand. Damp
*HB-4LW	5"	8 5/8"	7 5/8"	4" x 6"	3"	1-60W, A15	Incand. Wet

Low Voltage Landscape

Overlay Design Options

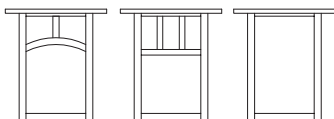

*Classic Arch (A) Double T-bar (DT) Empty (E)

LV24-H4DTGW-MB
 Frame: LV24-H4
 Overlay: Double T-bar (DT)
 Glass: Gold White Iridescent (GW)
 Finish: Mission Brown (MB)



Specifications

Frame	Width	Height	Lamping	C-UL Rating
LV24-H4	4 1/4"	29"	1-18W, Low Voltage T-5 Wedge	Incand. Wet



HS-8DTWO-VP

Frame: HS-8
 Overlay: Double T-bar (DT)
 Glass: White Opalescent (WO)
 Finish: Verdigris Patina (VP)



HS-10DTWO-BK

Frame: HS-10
 Overlay: Double T-bar (DT)
 Glass: White Opalescent (WO)
 Finish: Satin Black (BK)



HS-12DTWO-BZ

Frame: HS-12
 Overlay: Double T-bar (DT)
 Glass: White Opalescent (WO)
 Finish: Bronze (BZ)



HS-14SDTWO-BZ

Frame: HS-14S
 Overlay: Double T-bar (DT)
 Glass: White Opalescent (WO)
 Finish: Bronze (BZ)



HLB-24DTWO-P

Frame: HLB-24
 Overlay: Double T-bar (DT)
 Glass: White Opalescent (WO)
 Finish: Pewter (P)

Overlay Design Options

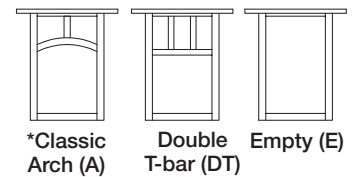

Specifications

Frame	Width	Height	Depth	Mounting Base	Mounting Center to Top	Lamping	C-UL Rating
HLB-24	26 7/8"	5 7/8"	7"	5 7/8" x 24"	3"	3-60W, Medium	Incand. Damp
*HS-8	7 1/4"	7 7/8"	5 1/4"	5 1/8" x 7 7/8"	4"	1-100W, Medium	Incand. Wet
*HS-10	9 1/8"	10"	5 3/4"	6 5/8" x 10"	5"	1-100W, Medium	Incand. Wet
*HS-12	9 1/2"	12"	6"	6 5/8" x 12"	6"	1-100W, Medium	Incand. Wet
HS-14S	13 1/2"	6 1/2"	5 3/8"	12" x 6 1/2"	3 1/4"	2-60W, Medium	Incand. Wet



HH-4LDTGW-VP
 Frame: HH-4L
 Overlay: Double T-bar (DT)
 Glass: Gold White Iridescent (GW)
 Finish: Verdigris Patina (VP)



HCH-4L/4-1DTCR-AC
 Frame: HCH-4L/4-1
 Overlay: Double T-bar (DT)
 Glass: Cream (CR)
 Finish: Antique Copper (AC)



HSH-4LDTF-P
 Frame: HSH-4L
 Overlay: Double T-bar (DT)
 Glass: Frosted (F)
 Finish: Pewter (P)



HICH-4L/3DTAM-BZ
 Frame: HICH-4L/3
 Overlay: Double T-bar (DT)
 Glass: Almond Mica (AM)
 Finish: Bronze (BZ)

Specifications

Frame	Body Width	Overall Width	Height	Extension	Mounting Base	Lamping	C-UL Rating
HICH-4L/3	4 1/4"	24"	6 1/2"	30"	4 1/2" x 24"	3-60W, A15	Incand. Dry
HCH-4L/4-1	4 1/4"	23 1/2"	25 1/4"	61 1/4"	4 1/4" sq.	5-60W, A15	Incand. Dry
HH-4L	5"	7 5/8"	43 5/8"	43 5/8"	4 1/4" sq.	1-60W, A15	Incand. Damp
HSH-4L	5"	6 1/2"	29 3/4"	29 3/4"	4 1/4" sq.	1-60W, A15	Incand. Wet

PENDANT MOUNTING BASE





HCM-4L/1DTGW-VP

Frame: HCM-4L/1
 Overlay: Double T-bar (DT)
 Glass: Gold White Iridescent (GW)
 Finish: Verdigris Patina (VP)



HCM-4L/2DTGW-BZ

Frame: HCM-4L/2
 Overlay: Double T-bar (DT)
 Glass: Gold White Iridescent (GW)
 Finish: Bronze (BZ)



HCM-4L/4DTCR-BZ

Frame: HCM-4L/4
 Overlay: Double T-bar (DT)
 Glass: Cream (CR)
 Finish: Bronze (BZ)

Specifications

Frame	Width	Height	Mounting Base	Lamping	C-UL Rating
*HCM-4L/1	5"	10"	4 ¼" sq.	1-60W, A15	Incand. Dry
*HCM-4L/2	15"	10 ⅛"	4 ½" x 14"	2-60W, A15	Incand. Dry
*HCM-4L/4	17"	10 ⅛"	15" sq.	4-60W, A15	Incand. Dry

Overlay Design Options

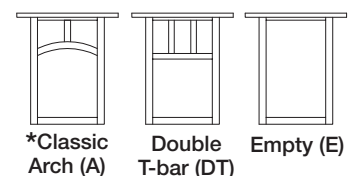

HCM-12DTWO-BZ

Frame: HCM-12
 Overlay: Double T-bar (DT)
 Glass: White Opalescent (WO)
 Finish: Bronze (BZ)



HCM-15DTWO-BZ

Frame: HCM-15
 Overlay: Double T-bar (DT)
 Glass: White Opalescent (WO)
 Finish: Bronze (BZ)



HCM-14DTWO-AB

Frame: HCM-14
 Overlay: Double T-bar (DT)
 Glass: White Opalescent (WO)
 Finish: Antique Brass (AB)

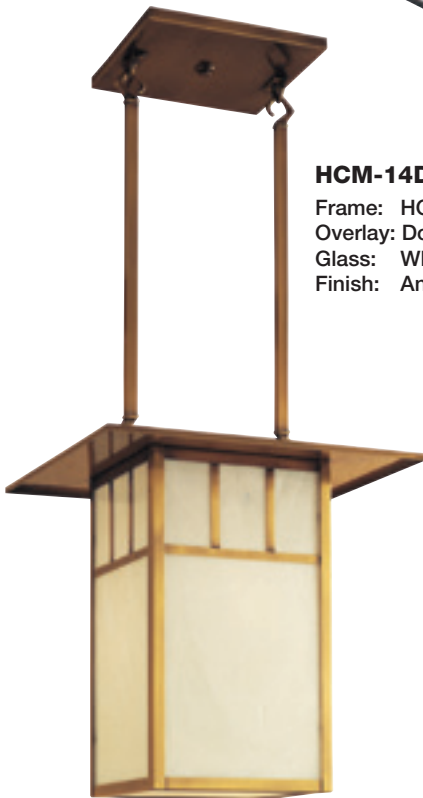

HCM-18DTWO-AB

Frame: HCM-18
 Overlay: Double T-bar (DT)
 Glass: White Opalescent (WO)
 Finish: Antique Brass (AB)



Specifications

Frame	Width	Height	Extension	Mounting Base	Lamping	C-UL Rating
HCM-12	12"	7 3/8"		9 1/2" sq.	2-100W, Medium	Incand. Dry
HCM-14	14"	14"	32 1/4"	8" sq.	2-100W, Medium	Incand. Dry
HCM-15	15"	9"		12" sq.	2-100W, Medium	Incand. Dry
HCM-18	18"	18"	41 3/4"	10" sq.	2-100W, Medium	Incand. Dry



HCM-35DTWO-AB

Frame: HCM-35
 Overlay: Double T-bar (DT)
 Glass: White Opalescent (WO)
 Finish: Antique Brass (AB)



HCM-27DTGW-BZ

Frame: HCM-27
 Overlay: Double T-bar (DT)
 Glass: Gold White Iridescent (GW)
 Finish: Bronze (BZ)

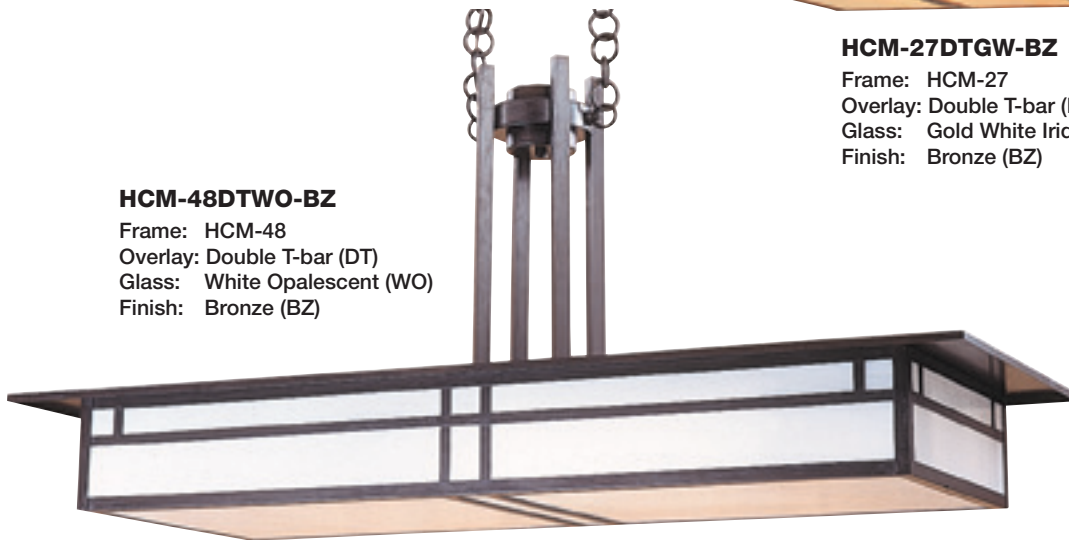

HCM-48DTWO-BZ

Frame: HCM-48
 Overlay: Double T-bar (DT)
 Glass: White Opalescent (WO)
 Finish: Bronze (BZ)

Specifications

Frame	Width	Height	Extension	Mounting Base	Lamping	C-UL Rating
HCM-27	17 1/2" x 27 3/4"	7 3/4"	29 5/8"	16 3/8" x 7 1/4"	4-60W, Medium	Incand. Dry
HCM-35	8 5/8" x 35"	22 1/2"	58 1/2"	4" x 8"	2-150W, Medium	Incand. Dry
HCM-48	22" x 47 1/2"	22 1/2"	58 1/2"	4 1/4" x 10"	4-100W, Medium	Incand. Dry

Inverness

Wall Mounts & Pendants



INB-8GRCS-BK
 Frame: INB-8GR (Glass Roof)
 Glass: Clear Seedy (CS)
 Finish: Satin Black (BK)



INB-10GRCLR-BZ
 Frame: INB-10GR (Glass Roof)
 Glass: Clear (CLR)
 Finish: Bronze (BZ)

INH-8GRCS-BK
 Frame: INH-8GR (Glass Roof)
 Glass: Clear Seedy (CS)
 Finish: Satin Black (BK)



INH-10GRCLR-P
 Frame: INH-10GR (Glass Roof)
 Glass: Clear (CLR)
 Finish: Pewter (P)



Specifications

Frame	Width	Height	Depth	Ext.	Mounting Base	Mounting Center to Top	Lamping	C-UL Rating
INB-8GR	8"	18"	10 ½"		4" x 8"	10 ½"	3-60W, Candle Clear	Incand. Wet
INB-10GR	10 ¼"	23"	13 ½"		5" x 11 ½"	13 ½"	3-60W, Candle Clear	Incand. Wet
INH-8GR	8"	16"		52"	4 ¼" sq.		3-60W, Candle Clear	Incand. Damp
INH-10GR	10 ¼"	19 ½"		55 ½"	4 ¼" sq.		3-60W, Candle Clear	Incand. Damp



INC-8GRCS-AB

Frame: INC-8GR (Glass Roof)
 Glass: Clear Seedy (CS)
 Finish: Antique Brass (AB)



INC-10GRCLR-VP

Frame: INC-10GR (Glass Roof)
 Glass: Clear (CLR)
 Finish: Verdigris Patina (VP)



INP-10GRCLR-AB

Frame: INP-10GR (Glass Roof)
 Glass: Clear (CLR)
 Finish: Antique Brass (AB)

Specifications

Frame	Width	Height	Mounting Base	Lamping	C-UL Rating
INC-8GR	8"	15"	6" sq.	3-60W, Candle Clear	Incand. Wet
INC-10GR	10 ¼"	18 ½"	8" sq.	3-60W, Candle Clear	Incand. Wet
INP-10GR	10 ¼"	16"		3-60W, Candle Clear	Incand. Wet

Inverness

Wall Mounts & Pendants



INB-8MRCLR-BK

Frame: INB-10MR (Metal Roof)
Glass: Clear (CLR)
Finish: Satin Black (BK)

INB-10MRCLR-VP

Frame: INB-10MR (Metal Roof)
Glass: Clear (CLR)
Finish: Verdigris Patina (VP)



INH-10MRCLR-AB

Frame: INH-10MR (Metal Roof)
Glass: Clear (CLR)
Finish: Antique Brass (AB)



INH-8MRDD-BZ

Frame: INH-8MR (Metal Roof)
Glass: Dew Drop (DD)
Finish: Bronze (BZ)

Specifications

Frame	Width	Height	Depth	Extension	Mounting Base	Mounting Center to Top	Lamping	C-UL Rating
INB-8MR	8"	18"	10 ½"		4" x 8"	10 ½"	3-60W, Candle Clear	Incand. Wet
INB-10MR	10 ¼"	23"	13 ½"		5" x 11 ½"	13 ½"	3-60W, Candle Clear	Incand. Wet
INH-8MR	8"	16"		52"	4 ¼" sq.		3-60W, Candle Clear	Incand. Damp
INH-10MR	10 ¼"	19 ½"		55 ½"	4 ¼" sq.		3-60W, Candle Clear	Incand. Damp



INC-8MRCS-VP
 Frame: INC-8MR (Metal Roof)
 Glass: Clear Seedy (CS)
 Finish: Verdigris Patina (VP)



INC-10MRCLR-BK
 Frame: INC-10MR (Metal Roof)
 Glass: Clear (CLR)
 Finish: Satin Black (BK)



INP-8MRCLR-VP
 Frame: INP-8MR (Metal Roof)
 Glass: Clear (CLR)
 Finish: Verdigris Patina (VP)

INP-10MRCLR-BZ
 Frame: INP-10MR (Metal Roof)
 Glass: Clear (CLR)
 Finish: Bronze (BZ)



Specifications

Frame	Width	Height	Mounting Base	Lamping	C-UL Rating
INC-8MR	8"	15"	6" sq.	3-60W, Candle Clear	Incand. Wet
INC-10MR	10 ¼"	18 ½"	8" sq.	3-60W, Candle Clear	Incand. Wet
INP-8MR	8"	13"		3-60W, Candle Clear	Incand. Wet
INP-10MR	10 ¼"	16"		3-60W, Candle Clear	Incand. Wet





KAB-90F-BZ
 Frame: KAB-9
 Glass: Off White (OF)
 Finish: Bronze (BZ)



KAB-70F-BZ
 Frame: KAB-7
 Glass: Off White (OF)
 Finish: Bronze (BZ)



KAB-120F-BZ
 Frame: KAB-12
 Glass: Off White (OF)
 Finish: Bronze (BZ)



KAH-90F-BZ
 Frame: KAH-9
 Glass: Off White (OF)
 Finish: Bronze (BZ)

Specifications

Frame	Width	Height	Depth	Extension	Mounting Base	Mounting Center to Top	Lamping	C-UL Rating
KAB-7	7"	11"	7 ½"		4" x 6"	3"	1-100W, Medium	Incand. Wet
KAB-9	9"	13 ½"	9 ½"		4" x 6"	3"	1-100W, Medium	Incand. Wet
KAB-12	12"	16 ½"	12 ½"		4" x 8"	4"	1-100W, Medium	Incand. Wet
KAH-9	9"	13 ½"		49 ½"	4 ¼"		1-100W, Medium	Incand. Damp



KAC-7CS-BZ

Frame: KAC-7
Glass: Clear Seedy (CS)
Finish: Bronze (BZ)



KAC-9CS-BZ

Frame: KAC-9
Glass: Clear Seedy (CS)
Finish: Bronze (BZ)



KAC-12TN-BZ

Frame: KAC-12
Glass: Tan (TN)
Finish: Bronze (BZ)

Specifications

Frame	Width	Height	Mounting Base	Lamping	C-UL Rating
KAC-7	7"	10 ½"	6" sq.	1-100W, Medium	Incand. Wet
KAC-9	9"	13"	7 ½" sq.	1-100W, Medium	Incand. Wet
KAC-12	12"	16"	10" sq.	1-100W, Medium	Incand. Wet



KAP-9WO-BZ

Frame: KAP-9
Glass: White Opalescent (WO)
Finish: Bronze (BZ)



KAP-7WO-BZ

Frame: KAP-7
Glass: White Opalescent (WO)
Finish: Bronze (BZ)



KAP-12WO-VP

Frame: KAP-12
Glass: White Opalescent (WO)
Finish: Verdigris Patina (VP)

Specifications

Frame	Width	Height	Lamping	C-UL Rating
KAP-7	7"	11"	1-100W, Medium	Incand. Wet
KAP-9	9"	13 ½"	1-100W, Medium	Incand. Wet
KAP-12	12"	16 ½"	1-100W, Medium	Incand. Wet



KB-9WO-RC

Frame: KB-9
Glass: White Opalescent (WO)
Finish: Raw Copper (RC)



KB-12GW-BZ

Frame: KB-12
Glass: Gold White Iridescent (GW)
Finish: Bronze (BZ)



KH-9GW-VP

Frame: KH-9
Glass: Gold White Iridescent (GW)
Finish: Verdigris Patina (VP)



KH-12GW-VP

Frame: KH-12
Glass: Gold White Iridescent (GW)
Finish: Verdigris Patina (VP)

Specifications

Frame	Width	Height	Depth	Extension	Mounting Base	Mounting Center to Top	Lamping	C-UL Rating
KB-9	8 3/4"	13 1/2"	9 1/2"		4" x 6"	3 1/8"	1-100W, Medium	Incand. Wet
KB-12	12 1/4"	17 1/2"	13"		4" x 8"	4 1/8"	1-100W, Medium	Incand. Wet
KH-9	8 3/4"	12 1/4"		48 1/4"	4 1/4" sq.		1-100W, Medium	Incand. Damp
KH-12	12 1/4"	17"		53"	4 1/4" sq.		1-100W, Medium	Incand. Damp



KC-9CS-RC
 Frame: KC-9
 Glass: Clear Seedy (CS)
 Finish: Raw Copper (RC)



KC-12F-RC
 Frame: KC-12
 Glass: Frosted (F)
 Finish: Raw Copper (RC)



KP-9GW-RC
 Frame: KP-9
 Glass: Gold White Iridescent (GW)
 Finish: Raw Copper (RC)



KP-12RM-VP
 Frame: KP-12
 Glass: Rain Mist (RM)
 Finish: Verdigris Patina (VP)

Specifications

Frame	Width	Height	Mounting Base	Lamping	C-UL Rating
KC-9	8 3/4"	12 1/8"	6 3/4" sq.	1-60W, Medium	Incand. Wet
KC-12	12 1/4"	16 5/8"	9 1/8" sq.	1-100W, Medium	Incand. Wet
KP-9	8 3/4"	11 1/4"		1-60W, Medium	Incand. Wet
KP-12	12 1/4"	15 5/8"		1-100W, Medium	Incand. Wet

Lancaster

Wall Mounts & Pendants

LAB-6CLR-BZ/RC

Frame: LAB-6
Glass: Clear (CLR)
Finish: Bronze with Raw
Copper Accents (BZ/RC)



LAB-9CLR-BZ/RC

Frame: LAB-9
Glass: Clear (CLR)
Finish: Bronze with Raw
Copper Accents (BZ/RC)



LAB-12CS-BZ/RC

Frame: LAB-12
Glass: Clear Seedy (CS)
Finish: Bronze with Raw
Copper Accents (BZ/RC)



LAH-12CLR-BZ/RC

Frame: LAH-12
Glass: Clear (CLR)
Finish: Bronze with Raw
Copper Accents (BZ/RC)

LAH-9DD-BZ/RC

Frame: LAH-9
Glass: Dew Drop (DD)
Finish: Bronze with Raw
Copper Accents (BZ/RC)



Specifications

Frame	Width	Height	Depth	Ext.	Mounting Base	Mounting Center to Top	Lamping	C-UL Rating
LAB-6	5 1/2"	9"	6"		4 1/4" sq.	5"	1-100W, Medium	Incand. Wet
LAB-9	9"	20 1/2"	10"		4" x 6"	11 1/4"	2-60W, Candle Clear	Incand. Wet
LAB-12	12"	24 1/2"	13"		5" x 8"	13"	2-60W, Candle Clear	Incand. Wet
LAH-9	9"	18 1/2"		54 1/2"	4 1/4" sq.		2-60W, Candle Clear	Incand. Damp
LAH-12	12"	23"		59"	4 1/4" sq.		2-60W, Candle Clear	Incand. Damp



LAC-9CS-BZ/RC
 Frame: LAC-9
 Glass: Clear Seedy (CS)
 Finish: Bronze with Raw
 Copper Accents (BZ/RC)

LAC-12RM-RC
 Frame: LAC-12
 Glass: Rain Mist (RM)
 Finish: Raw Copper (RC)



LAP-12CLR-BZ
 Frame: LAP-12
 Glass: Clear (CLR)
 Finish: Bronze (BZ)



LAP-9CS-VP
 Frame: LAP-9
 Glass: Clear Seedy (CS)
 Finish: Verdigris Patina (VP)

Specifications

Frame	Width	Height	MountingBase	Lamping	C-UL Rating
LAC-9	9"	21"	6" sq.	2-60W, Candle Clear	Incand. Wet
LAC-12	12"	26"	8" sq.	2-60W, Candle Clear	Incand. Wet
LAP-9	9"	20"		2-60W, Candle Clear	Incand. Wet
LAP-12	12"	25"		2-60W, Candle Clear	Incand. Wet



LYW-7AE-BK
 Frame: LYW-7
 Glass: Aerolite (AE)
 Finish: Satin Black (BK)



LYW-5AE-BK
 Frame: LYW-5
 Glass: Aerolite (AE)
 Finish: Satin Black (BK)



LYW-9AE-BK
 Frame: LYW-9
 Glass: Aerolite (AE)
 Finish: Satin Black (BK)

Specifications

Frame	Width	Height	Depth	Mounting Base	Mounting Center to Top	Lamping	C-UL Rating
LYW-5	5"	8"	5 ½"	4" x 4"	4"	1-100W, Medium	Incand. Wet
LYW-7	7"	16 ½"	7 ½"	4" x 6"	6 ½"	2-60W, Candle Clear	Incand. Wet
LYW-9	9"	21"	10"	5" x 8"	8"	2-60W, Candle Clear	Incand. Wet

Chandelier, Pendant, Column & Post Mounts

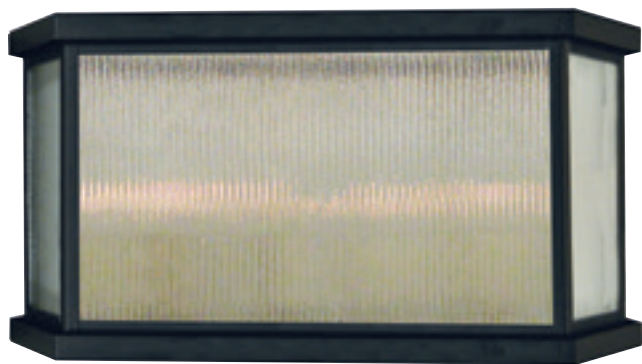

LYC-14AE-BK

Frame: LYC-14
Glass: Aerolite (AE)
Finish: Satin Black (BK)



LYP-7RM-MB

Frame: LYP-7
Glass: Rain Mist (RM)
Finish: Mission Brown (MB)



LYH-7CLR-BZ

Frame: LYH-7
Glass: Clear (CLR)
Finish: Bronze (BZ)



LYCH-26AE-AB

Frame: LYCH-26
Glass: Aerolite (AE)
Finish: Antique Brass (AB)

Specifications

Frame	Width	Height	Extension	Mounting Base	Lamping	C-UL Rating
LYH-7	7"	13"	49"	4 1/4" sq	2-60W, Candle Clear	Incand. Damp
LYCH-26	26"	10"	36"	5"	4-60W, Candle Clear	Incand. Dry
LYP-7	7"	11 1/2"			2-60W, Candle Clear	Incand. Wet
LYC-14	14"	9"		14"	4-60W, Candle Clear	Incand. Wet

Mission

Reminiscent of California Mission Revival and Southwestern architecture, which is both solid and enduring this is a family which meets the test of time.





MB-5TWO-RC
 Frame: MB-5
 Overlay: T-bar (T)
 Glass: White Opalescent (WO)
 Finish: Raw Copper (RC)



MB-6TOF-RB
 Frame: MB-6
 Overlay: T-bar (T)
 Glass: Off White (OF)
 Finish: Rustic Brown (RB)



MB-7TGW-VP
 Frame: MB-7
 Overlay: T-bar (T)
 Glass: Gold White Iridescent (GW)
 Finish: Verdigris Patina (VP)



MB-15TRM-MB
 Frame: MB-15
 Overlay: T-bar (T)
 Glass: Rain Mist (RM)
 Finish: Mission Brown (MB)



MB-10TRM-MB
 Frame: MB-10
 Overlay: T-bar (T)
 Glass: Rain Mist (RM)
 Finish: Mission Brown (MB)

Specifications

Frame	Width	Height	Depth	Mounting Base	Mounting Center to Top	Lamping	C-UL Rating
MB-5	4 7/8"	8 5/8"	7 5/8"	4" x 6"	4 3/4"	1-100W, Medium	Incand. Damp
MB-6	6"	10 3/8"	9 1/2"	4" x 8"	4 1/8"	1-100W, Medium	Incand. Damp
MB-7	7 1/4"	11 5/8"	10 1/4"	4" x 8"	4 1/8"	1-100W, Medium	Incand. Damp
MB-10	10"	16"	13 3/8"	5" x 11"	7 1/8"	1-100W, Medium	Incand. Damp
MB-15	15"	24 7/8"	19 1/8"	6" x 15"	6 3/8"	1-150W, Medium	Incand. Damp

Overlay Design Options

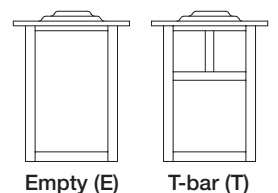



MW-6TTN-RC
 Frame: MW-6
 Overlay: T-bar (T)
 Glass: Tan (TN)
 Finish: Raw Copper (RC)



MW-10TGW-MB
 Frame: MW-10
 Overlay: T-bar (T)
 Glass: Gold White Iridescent (GW)
 Finish: Mission Brown (MB)



MW-15TGW-MB
 Frame: MW-15
 Overlay: T-bar (T)
 Glass: Gold White Iridescent (GW)
 Finish: Mission Brown (MB)



MW-7TCR-BZ
 Frame: MW-7
 Overlay: T-bar (T)
 Glass: Cream (CR)
 Finish: Bronze (BZ)



MS-8TWO-MB
 Frame: MS-8
 Overlay: T-bar (T)
 Glass: White Opalescent (WO)
 Finish: Mission Brown (MB)



MS-10TGW-VP
 Frame: MS-10
 Overlay: T-bar (T)
 Glass: Gold White Iridescent (GW)
 Finish: Verdigris Patina (VP)



MS-12TOF-BZ
 Frame: MS-12
 Overlay: T-bar (T)
 Glass: Off White (OF)
 Finish: Bronze (BZ)

Specifications

Frame	Width	Height	Depth	Mounting Base	Mounting Center to Top	Lamping	C-UL Rating
MW-6	5 7/8"	7 1/4"	5 7/8"	4 5/8" sq.	2 5/16"	1-100W, Medium	Incand. Wet
MW-7	7"	8 1/2"	7"	5 1/2" sq.	2 3/4"	1-100W, Medium	Incand. Wet
MW-10	10"	12"	10"	8" sq.	4"	1-100W, Medium	Incand. Wet
MW-15	15"	18"	15"	12" sq.	6"	2-75W, Medium	Incand. Wet
MS-8	5 1/8"	7 7/8"	4 1/4"		4"	1-100W, Medium	Incand. Dry
MS-10	6 5/8"	10"	4 5/8"		5"	1-100W, Medium	Incand. Dry
MS-12	6 5/8"	12"	4 5/8"		6"	1-100W, Medium	Incand. Dry

Overlay Design Options

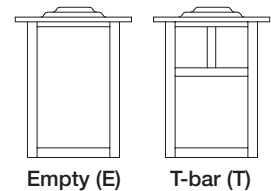

MCM-5/2TGW-BZ

Frame: MCM-5/2
 Overlay: T-bar (T)
 Glass: Gold White Iridescent (GW)
 Finish: Bronze (BZ)



MCM-5/4TCR-BZ

Frame: MCM-5/4
 Overlay: T-bar (T)
 Glass: Cream (CR)
 Finish: Bronze (BZ)

MCM-6/4TWO-BZ

Frame: MCM-6/4
 Overlay: T-bar (T)
 Glass: White Opalescent (WO)
 Finish: Bronze (BZ)

MCM-6/2TGW-AB

Frame: MCM-6/2
 Overlay: T-bar (T)
 Glass: Gold White Iridescent (GW)
 Finish: Antique Brass (AB)



MCM-7TWO-VP

Frame: MCM-7
 Overlay: T-bar (T)
 Glass: White Opalescent (WO)
 Finish: Verdigris Patina (VP)



MCM-8TWO-VP

Frame: MCM-8
 Overlay: T-bar (T)
 Glass: White Opalescent (WO)
 Finish: Verdigris Patina (VP)

MCM-12TGW-BZ

Frame: MCM-12
 Overlay: T-bar (T)
 Glass: Gold White Iridescent (GW)
 Finish: Bronze (BZ)



MCM-18TGW-BZ

Frame: MCM-18
 Overlay: T-bar (T)
 Glass: Gold White Iridescent (GW)
 Finish: Bronze (BZ)

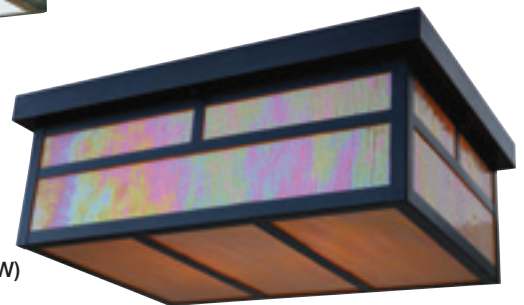

Specifications

Frame	Width	Height	Mounting Base	Lamping	C-UL Rating
MCM-5/2	14 7/8"	10"	4 1/2" x 14"	2-60W, Medium	Incand. Dry
MCM-5/4	16 7/8"	10"	15" sq.	4-60W, Medium	Incand. Dry
MCM-6/2	16"	11 3/8"	4 1/2" x 14"	2-60W, Medium	Incand. Dry
MCM-6/4	18"	11 3/8"	15" sq.	4-60W, Medium	Incand. Dry
MCM-7	7"	5 1/4"	8 1/2" sq.	1-60W, Medium	Incand. Damp
MCM-8	8 3/8"	6 1/4"	9 3/4" sq.	2-60W, Medium	Incand. Damp
MCM-12	12"	7 1/4"	13 1/2" sq.	2-60W, Medium	Incand. Damp
MCM-18	12 x 18"	7 1/4"	13 1/2" x 19 5/8"	2-60W, Medium	Incand. Damp



MH-5TWO-BK

Frame: MH-5
 Overlay: T-bar (T)
 Glass: White Opalescent (WO)
 Finish: Satin Black (BK)



MH-6TF-RB

Frame: MH-6
 Overlay: T-bar (T)
 Glass: Frosted (F)
 Finish: Rustic Brown (RB)



MH-7TTN-BZ

Frame: MH-7
 Overlay: T-bar (T)
 Glass: Tan (TN)
 Finish: Bronze (BZ)



MH-10TWO-RC

Frame: MH-10
 Overlay: T-bar (T)
 Glass: White Opalescent (WO)
 Finish: Raw Copper (RC)



MH-15TGW-VP

Frame: MH-15
 Overlay: T-bar (T)
 Glass: Gold White Iridescent (GW)
 Finish: Verdigris Patina (VP)

Overlay Design Options

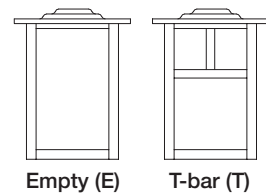

Specifications

Frame	Width	Height	Extension	Mounting Base	Lamping	C-UL Rating
MH-5	4 7/8"	7 1/2"	43 1/2"	4 1/4" sq.	1-100W, Medium	Incand. Damp
MH-6	6"	8 7/8"	44 7/8"	4 1/4" sq.	1-100W, Medium	Incand. Damp
MH-7	7 1/4"	10 1/4"	46 1/4"	4 1/4" sq.	1-100W, Medium	Incand. Damp
MH-10	10"	14 3/8"	50 3/8"	4 1/4" sq.	1-100W, Medium	Incand. Damp
MH-15	15"	22 3/8"	58 3/8"	4 1/4" sq.	1-150W, Medium	Incand. Damp

MSH-6TGW-VP

Frame: MSH-6
 Overlay: T-bar (T)
 Glass: Gold White Iridescent (GW)
 Finish: Verdigris Patina (VP)



MSH-7TWO-P

Frame: MSH-7
 Overlay: T-bar (T)
 Glass: White Opalescent (WO)
 Finish: Pewter (P)



MSH-10TWO-P

Frame: MSH-10
 Overlay: T-bar (T)
 Glass: White Opalescent (WO)
 Finish: Pewter (P)

Specifications

Frame	Width	Height	Extension	Mounting Base	Lamping	C-UL Rating
MSH-6	6"	8 7/8"	37 5/8"	4 1/4" sq.	1-100W, Medium	Incand. Damp
MSH-7	7 1/4"	10 1/4"	39"	4 1/4" sq.	1-100W, Medium	Incand. Damp
MSH-10	10"	14 3/8"	43"	4 1/4" sq.	1-100W, Medium	Incand. Damp

PENDANT MOUNTING BASE



Mission

Column & Post Mounts



MC-7TWO-BZ

Frame: MC-7
 Overlay: T-bar (T)
 Glass: White Opalescent (WO)
 Finish: Bronze (BZ)



MC-10TGW-MB

Frame: MC-10
 Overlay: T-bar (T)
 Glass: Gold White Iridescent (GW)
 Finish: Mission Brown (MB)



MC-15TWO-VP

Frame: MC-15
 Overlay: T-bar (T)
 Glass: White Opalescent (WO)
 Finish: Verdigris Patina (VP)



MPC-5TGW-MB

Frame: MPC-5
 Overlay: T-bar (T)
 Glass: Gold White Iridescent (GW)
 Finish: Mission Brown (MB)



MPC-6TOF-RC

Frame: MPC-6
 Overlay: T-bar (T)
 Glass: Off White (OF)
 Finish: Raw Copper (RC)



MPC-7TGW-MB

Frame: MPC-7
 Overlay: T-bar (T)
 Glass: Gold White Iridescent (GW)
 Finish: Mission Brown (MB)

Specifications

Frame	Width	Height	Mounting Base	Lamping	C-UL Rating
MC-7	7"	10 5/8"	6 1/2" sq.	1-60W, A19	Incand. Wet
MC-10	10"	14 3/4"	9 5/8" sq.	1-100W, A19	Incand. Wet
MC-15	15"	23 1/4"	13 3/8" sq.	1-150W, A19	Incand. Wet
MPC-5	5"	6 3/4"		1-60W, A19	Incand. Wet
MPC-6	6"	8 1/2"		1-60W, A19	Incand. Wet
MPC-7	7"	10"		1-60W, A19	Incand. Wet

MP-6TCR-RC

Frame: MP-6
 Overlay: T-bar (T)
 Glass: Cream (CR)
 Finish: Raw Copper (RC)



MP-5TGW-RB

Frame: MP-5
 Overlay: T-bar (T)
 Glass: Gold White Iridescent (GW)
 Finish: Rustic Brown (RB)



MP-7TGW-VP

Frame: MP-7
 Overlay: T-bar (T)
 Glass: Gold White Iridescent (GW)
 Finish: Verdigris Patina (VP)



MP-10TGW-VP

Frame: MP-10
 Overlay: T-bar (T)
 Glass: Gold White Iridescent (GW)
 Finish: Verdigris Patina (VP)

Specifications

Frame	Width	Height	Lamping	C-UL Rating
MP-5	5"	6 ¾"	1-60W, A19	Incand. Wet
MP-6	6"	8 ½"	1-60W, A19	Incand. Wet
MP-7	7"	10"	1-60W, A19	Incand. Wet
MP-10	10"	13 ¼"	1-100W, A19	Incand. Wet



MSP-5TF-BK
 Frame: MSP-5
 Overlay: T-bar (T)
 Glass: Frosted (F)
 Finish: Satin Black (BK)



MSP-6TF-BK
 Frame: MSP-6
 Overlay: T-bar (T)
 Glass: Frosted (F)
 Finish: Satin Black (BK)



MSP-7TF-BK
 Frame: MSP-7
 Overlay: T-bar (T)
 Glass: Frosted (F)
 Finish: Satin Black (BK)

Specifications

Frame	Width	Height	Lamping	C-UL Rating
MSP-5	5"	18 ¼"	1-60W, A19	Incand. Wet
MSP-6	6"	20"	1-60W, A19	Incand. Wet
MSP-7	7"	21 ½"	1-60W, A19	Incand. Wet

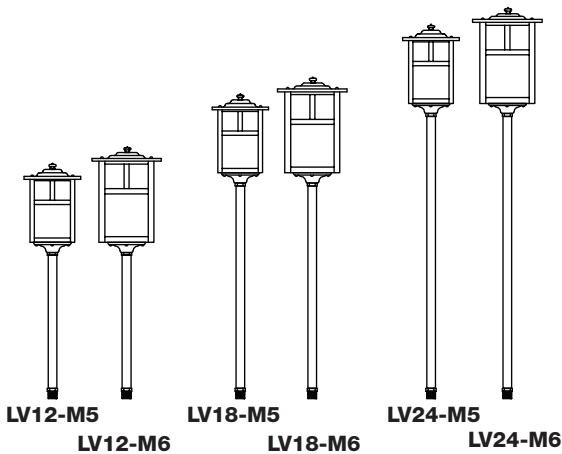

LV12-M5

LV12-M6

LV18-M5

LV18-M6

LV24-M5

LV24-M6



LV12-M6TCS-BK

Frame: LV12-M6
 Overlay: T-bar (T)
 Glass: Clear Seedy (CS)
 Finish: Satin Black (BK)



LV36-M6TGW-RC

Frame: LV36-M6
 Overlay: T-bar (T)
 Glass: Gold White Iridescent (GW)
 Finish: Raw Copper (RC)



LV27-M5TWO-BZ

Frame: LV27-M5
 Overlay: T-bar (T)
 Glass: White Opalescent (WO)
 Finish: Bronze (BZ)

Specifications

Frame	Width	Height	Lamping	C-UL Rating
LV12-M5	5"	18 ¾"	1-18W, Low Voltage T-5 Wedge	Incand. Wet
LV12-M6	6"	20 ½"	1-18W, Low Voltage T-5 Wedge	Incand. Wet
LV18-M5	5"	24 ¾"	1-18W, Low Voltage T-5 Wedge	Incand. Wet
LV18-M6	6"	26 ½"	1-18W, Low Voltage T-5 Wedge	Incand. Wet
LV24-M5	5"	30 ¾"	1-18W, Low Voltage T-5 Wedge	Incand. Wet
LV24-M6	6"	32 ½"	1-18W, Low Voltage T-5 Wedge	Incand. Wet
LV27-M5	5"	27"	1-18W, Low Voltage T-5 Wedge	Incand. Wet
LV27-M6	6"	27"	1-18W, Low Voltage T-5 Wedge	Incand. Wet
LV36-M5	5"	36"	1-18W, Low Voltage T-5 Wedge	Incand. Wet
LV36-M6	6"	36"	1-18W, Low Voltage T-5 Wedge	Incand. Wet

Mail Boxes

MMB-VP

Finish: Verdigris Patina (VP)

Specifications

Frame	Width	Height	Depth
MMB	8 ⅜"	12"	4 ½"
MMBL	17"	8 ½"	4 ½"



MMBL-VP

Finish: Verdigris Patina (VP)

Monterey

This series brings to mind the serenity of classic bungalows that feature the gentle touch of Asian aesthetics with their broad, pitched roofs and ornamental details.





MB-12CLDD-VP

Frame: MB-12
 Overlay: Cloud Lift (CL)
 Glass: Dew Drop (DD)
 Finish: Verdigris Patina (VP)



MB-17PFGW-VP

Frame: MB-17
 Overlay: Pine Needle Filigree (PF)
 Glass: Gold White Iridescent (GW)
 Finish: Verdigris Patina (VP)



MB-20TWO-BZ

Frame: MB-20
 Overlay: T-bar (T)
 Glass: White Opalescent (WO)
 Finish: Bronze (BZ)

Overlay Design Options

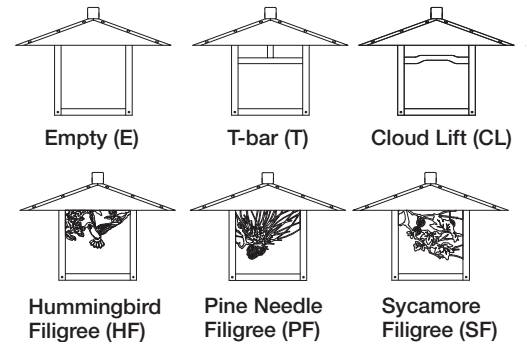

Specifications

Frame	Width	Height	Depth	Mounting Base	Mounting Center to Top	Lamping	C-UL Rating
MB-12	12"	11 7/8"	15 1/2"	4 1/2" x 9"	5 1/16"	1-100W, Medium	Incand. Damp
MB-17	17"	14 1/4"	20"	5" x 11"	6 13/16"	1-100W, Medium	Incand. Damp
MB-20	20"	16 7/8"	23 1/8"	5" x 11"	7 1/4"	1-100W, Medium	Incand. Damp



MH-12CLOF-VP

Frame: MH-12
 Overlay: Cloud Lift (CL)
 Glass: Off White (OF)
 Finish: Verdigris Patina (VP)



MH-17SFGW-VP

Frame: MH-17
 Overlay: Sycamore
 Filigree (SF)
 Glass: Gold White
 Iridescent (GW)
 Finish: Verdigris Patina (VP)



MH-20SFWO-RC

Frame: MH-20
 Overlay: Sycamore Filigree (SF)
 Glass: White Opalescent (WO)
 Finish: Raw Copper (RC)



MH-24TGW-BZ

Frame: MH-24
 Overlay: T-bar (T)
 Glass: Gold White
 Iridescent (GW)
 Finish: Bronze (BZ)



MH-30EGW-BZ

Frame: MH-30
 Overlay: Empty (E)
 Glass: Gold White
 Iridescent (GW)
 Finish: Bronze (BZ)

MH-36SFGW-VP

Frame: MH-36
 Overlay: Sycamore
 Filigree (SF)
 Glass: Gold White
 Iridescent (GW)
 Finish: Verdigris Patina (VP)



Specifications

Frame	Width	Height	Extension	Mounting Base	Lamping	C-UL Rating
MH-12	12"	10 ¼"	46 ¼"	4 ¼" sq.	1-100W, Medium	Incand. Damp
MH-17	17"	12"	48"	4 ¼" sq.	1-100W, Medium	Incand. Damp
MH-20	20"	13 ⅝"	49 ⅝"	4 ¼" sq.	1-100W, Medium	Incand. Damp
MH-24	24"	15 ⅞"	51 ⅞"	4 ¼" sq.	1-100W, Medium	Incand. Damp
MH-30	30"	15 ⅝"	51 ⅝"	4 ¼" sq.	1-100W, Medium	Incand. Damp
MH-36	36"	15 ⅝"	51 ⅝"	4 ¼" sq.	1-100W, Medium	Incand. Damp

MCH-12/4TCR-BZ

Frame: MCH-12
 Overlay: T-bar (T)
 Glass: Cream (CR)
 Finish: Bronze (BZ)



Specifications

Frame	Roof Width	Overall Width	Height	Extension	Mounting Base	Lamping	C-UL Rating
MCH-12/4	12"	41 ³ / ₈ "	29"	65"	6" sq.	4-60W, Medium	Incand. Dry



MP-17HFWO-RC

Frame: MP-17
 Overlay: Hummingbird Filigree (HF)
 Glass: White Opalescent (WO)
 Finish: Raw Copper (RC)



MP-12PFGW-MB

Frame: MP-12
 Overlay: Pine Tree Filigree (PF)
 Glass: Gold White Iridescent (GW)
 Finish: Mission Bronze (MB)

Overlay Design Options

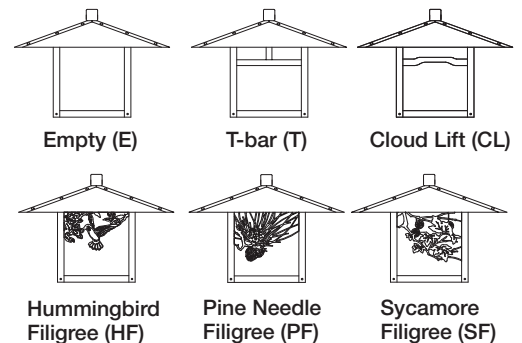

Specifications

Frame	Width	Height	Lamping	C-UL Rating
MP-12	12"	8"	1-100W, A19	Incand. Wet
MP-17	17"	11"	1-100W, A19	Incand. Wet



MC-12CLWO-VP
 Frame: MC-12
 Overlay: Cloud Lift (CL)
 Glass: White Opalescent (WO)
 Finish: Verdigris Patina (VP)



MC-17SFWO-VP
 Frame: MC-17
 Overlay: Sycamore Filigree (SF)
 Glass: White Opalescent (WO)
 Finish: Verdigris Patina (VP)



MC-20TGW-VP
 Frame: MC-20
 Overlay: T-bar (T)
 Glass: Gold White Iridescent (GW)
 Finish: Verdigris Patina



MC-24TWO-VP
 Frame: MC-24
 Overlay: T-bar (T)
 Glass: White Opalescent (WO)
 Finish: Verdigris Patina (VP)



MC-30PFWO-VP
 Frame: MC-30
 Overlay: Pine Needle Filigree (PF)
 Glass: White Opalescent (WO)
 Finish: Verdigris Patina (VP)



MC-36CLWO-VP
 Frame: MC-36
 Overlay: Cloud Lift (CL)
 Glass: White Opalescent (WO)
 Finish: Verdigris Patina (VP)

Specifications

Frame	Width	Height	Mounting Base	Lamping	C-UL Rating
MC-12	12"	9"	7" sq.	1-100W, A19	Incand. Wet
MC-17	17"	12 ¼"	9 ⅝" sq.	1-100W, A19	Incand. Wet
MC-20	20"	15 ½"	11 ½" sq.	1-100W, A19	Incand. Wet
MC-24	24"	17"	13 ⅜" sq.	1-100W, A19	Incand. Wet
MC-30	30"	17"	13 ⅜" sq.	1-100W, A19	Incand. Wet
MC-36	36"	17"	13 ⅜" sq.	1-100W, A19	Incand. Wet



NAB-8CS-BZ
 Frame: NAB-8
 Glass: Clear Seedy (CS)
 Finish: Bronze (BZ)



NAB-10CLR-RC
 Frame: NAB-10
 Glass: Clear (CLR)
 Finish: Raw Copper (RC)



NAH-10CS-BZ
 Frame: NAH-10
 Glass: Clear Seedy (CS)
 Finish: Bronze (BZ)

Specifications

Frame	Width	Height	Depth	Extension	Mounting Base	Mounting Center to Top	Lamping	C-UL Rating
NAB-8	8"	15 ½"	11"		4 ¼" x 6"	9 ½"	1-72W, Medium	Incand. Wet
NAB-10	10"	19"	13"		5" x 7"	12"	3-60W, Candle Clear	Incand. Wet
NAH-10	10"	15"		51"	4 ½" sq.		3-60W, Candle Clear	Incand. Damp



NAC-10CLR-RC
 Frame: NAC-10
 Glass: Clear (CLR)
 Finish: Raw Copper (RC)



NAP-10CLR-BK
 Frame: NAP-10
 Glass: Clear (CLR)
 Finish: Satin Black (BK)

Specifications

Frame	Width	Height	Depth	Extension	Mounting Base	Mounting Center to Top	Lamping	C-UL Rating
NAC-10	10"	15 ½"			6" sq.		3-60W, Candle Clear	Incand. Wet
NAP-10	10"	14 ½"					3-60W, Candle Clear	Incand. Wet

Newport

This series blends our Arts & Crafts inspired tradition of quality construction and attention to detail with a new approach, a nautical flair.





NB-9RM-BZ

Frame: NB-9
Glass: Rain Mist (RM)
Finish: Bronze (BZ)



NB-9LCS-BZ

Frame: NB-9L
Glass: Clear Seedy (CS)
Finish: Bronze (BZ)



NB-14LCS-BZ

Frame: NB-14L
Glass: Clear Seedy (CS)
Finish: Bronze (BZ)



NB-14CS-RC

Frame: NB-14
Glass: Clear Seedy (CS)
Finish: Raw Copper (RC)

Specifications

Frame	Width	Height	Depth	Mounting Base	Mounting Center to Top	Lamping	C-UL Rating
NB-9	9 1/4"	14 3/8"	10 5/8"	4" x 6"	5 3/4"	1-100W, Medium	Incand. Wet
NB-9L	9 1/4"	15 3/4"	10 5/8"	4" x 6"	5 3/4"	1-100W, Medium	Incand. Wet
NB-14	13 3/4"	24 1/2"	16"	5" x 11"	9 7/8"	1-100W, Medium	Incand. Wet
NB-14L	13 3/4"	27 1/8"	16"	5" x 11"	9 7/8"	1-100W, Medium	Incand. Wet



NS-9TN-BZ
 Frame: NS-9
 Glass: Tan (TN)
 Finish: Bronze (BZ)



NS-9LWO-VP
 Frame: NS-9L
 Glass: White Opalescent (WO)
 Finish: Verdigris Patina (VP)



NS-14TN-BZ
 Frame: NS-14
 Glass: Tan (TN)
 Finish: Bronze (BZ)



NS-14LOF-RC
 Frame: NS-14L
 Glass: Off White (OF)
 Finish: Raw Copper (RC)

Specifications

Frame	Width	Height	Depth	Mounting Base	Mounting Center to Top	Lamping	C-UL Rating
NS-9	9 ¼"	10 ⅝"	10 ¼"	4" x 6"	6 ½"	1-100W, Medium	Incand. Wet
NS-9L	9 ¼"	12 ⅞"	10 ¼"	4" x 6"	7 ¼"	1-100W, Medium	Incand. Wet
NS-14	13 ¾"	15 ⅜"	14 ¾"	5" x 11"	9 ⅝"	1-100W, Medium	Incand. Wet
NS-14L	13 ¾"	17 ⅞"	14 ¾"	5" x 11"	10 ⅞"	1-100W, Medium	Incand. Wet



NH-9GW-VP

Frame: NH-9
Glass: Gold White Iridescent (GW)
Finish: Verdigris Patina (VP)



NH-9LGW-VP

Frame: NH-9L
Glass: Gold White Iridescent (GW)
Finish: Verdigris Patina (VP)



NH-14OF-BZ

Frame: NH-14
Glass: Off White (OF)
Finish: Bronze (BZ)



NH-14LGW-VP

Frame: NH-14L
Glass: Gold White Iridescent (GW)
Finish: Verdigris Patina (VP)

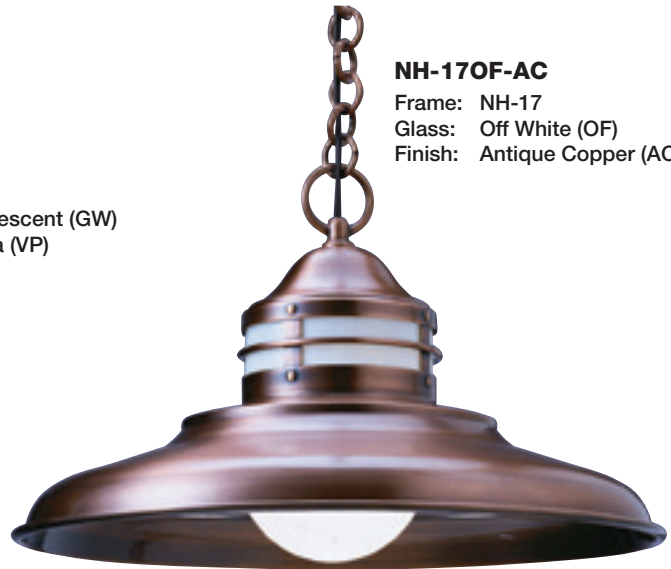

NH-17OF-AC

Frame: NH-17
Glass: Off White (OF)
Finish: Antique Copper (AC)

Specifications

Frame	Width	Height	Extension	Mounting Base	Lamping	C-UL Rating
NH-9	9 1/4"	12"	48"	5" Dia.	1-100W, Medium	Incand. Damp
NH-9L	9 1/4"	13 3/8"	49 3/8"	5" Dia.	1-100W, Medium	Incand. Damp
NH-14	13 3/4"	17 3/8"	61 3/8"	5" Dia.	1-100W, Medium	Incand. Damp
NH-14L	13 3/4"	19 7/8"	63 5/8"	5" Dia.	1-100W, Medium	Incand. Damp
NH-17	17"	10 3/8"	46 3/8"	5" Dia.	1-100W, Medium	Incand. Damp



NSH-9TN-BZ
 Frame: NSH-9
 Glass: Tan (TN)
 Finish: Bronze (BZ)



NSH-9LCS-BZ
 Frame: NSH-9L
 Glass: Clear Seedy (CS)
 Finish: Bronze (BZ)



NSH-14TN-BZ
 Frame: NSH-14
 Glass: Tan (TN)
 Finish: Bronze (BZ)



NSH-17CS-VP
 Frame: NSH-17
 Glass: Clear Seedy (CS)
 Finish: Verdigris Patina (VP)



NSH-14LCS-BZ
 Frame: NSH-14L
 Glass: Clear Seedy (CS)
 Finish: Bronze (BZ)

Specifications

Frame	Width	Height	Extension	Mounting Base	Lamping	C-UL Rating
NSH-9	9 ¼"	10 ¼"	34 ⅛"	5" Dia.	1-100W, Medium	Incand. Wet
NSH-9L	9 ¼"	11 ¾"	35 ½"	5" Dia.	1-100W, Medium	Incand. Wet
NSH-14	13 ¾"	15 ½"	38 ⅜"	5" Dia.	1-100W, Medium	Incand. Wet
NSH-14L	13 ¾"	17 ½"	41 ⅜"	5" Dia.	1-100W, Medium	Incand. Wet
NSH-17	17"	8 ⅛"	32"	5" Dia.	1-100W, Medium	Incand. Wet



NC-9CR-BZ
 Frame: NC-9
 Glass: Cream (CR)
 Finish: Bronze (BZ)



NC-9LOF-BK
 Frame: NC-9L
 Glass: Off White (OF)
 Finish: Satin Black (BK)



NC-14CR-BZ
 Frame: NC-14
 Glass: Cream (CR)
 Finish: Bronze (BZ)



NC-14LWO-BK
 Frame: NC-14L
 Glass: White Opalescent (WO)
 Finish: Satin Black (BK)

Specifications

Frame	Width	Height	Mounting Base	Lamping	C-UL Rating
NC-9	9 1/4"	11 5/8"	7" dia.	1-100W, Medium	Incand. Wet
NC-9L	9 1/4"	13 1/4"	7" dia.	1-100W, Medium	Incand. Wet
NC-14	13 3/4"	16 3/4"	10 1/2" dia.	1-100W, Medium	Incand. Wet
NC-14L	13 3/4"	19 1/4"	10 1/2" dia.	1-100W, Medium	Incand. Wet

NP-9CS-VP

Frame: NP-9
Glass: Clear Seedy (CS)
Finish: Verdigris Patina (VP)



NP-9LF-S

Frame: NP-9L
Glass: Frosted (F)
Finish: Slate (S)



NP-14RM-BK

Frame: NP-14
Glass: Rain Mist (RM)
Finish: Satin Black (BK)

NP-14LF-S

Frame: NP-14L
Glass: Frosted (F)
Finish: Slate (S)



Specifications

Frame	Width	Height	Lamping	C-UL Rating
NP-9	9 ¼"	13 ⅝"	1-100W, Medium	Incand. Wet
NP-9L	9 ¼"	15 ⅞"	1-100W, Medium	Incand. Wet
NP-14	13 ¾"	20"	1-100W, Medium	Incand. Wet
NP-14L	13 ¾"	22 ½"	1-100W, Medium	Incand. Wet

Nottingham

Wall Mounts & Pendants



NOH-8CS-BZ
 Frame: NOH-8
 Glass: Clear Seedy (CS)
 Finish: Bronze (BZ)

NOH-6CS-VP
 Frame: NOH-6
 Glass: Clear Seedy (CS)
 Finish: Verdigris Patina (VP)



NOB-6CS-RC
 Frame: NOB-6
 Glass: Clear Seedy (CS)
 Finish: Raw Copper (RC)

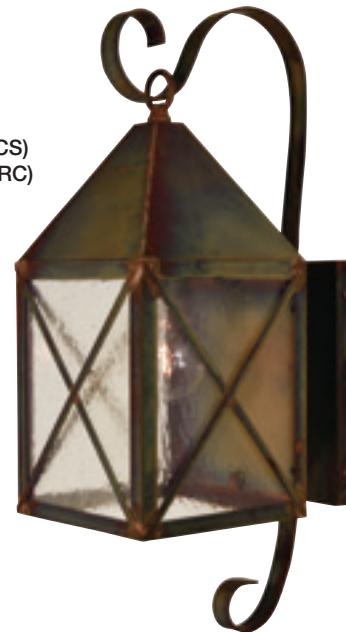

NOB-8CS-BK
 Frame: NOB-8
 Glass: Clear Seedy (CS)
 Finish: Satin Black (BK)

Specifications

Frame	Width	Height	Depth	Ext.	Mounting Base	Mounting Center to Top	Lamping	C-UL Rating
NOB-6	6"	18 ¾"	8"		4" x 7 ½"	11 ¾"	1-72W, Medium	Incand. Wet
NOB-8	8"	25"	10 ½"		5" x 10"	15 ½"	1-72W, Medium	Incand. Wet
NOH-6	6"	13 ½"		49 ½"	4 ¼" sq.		1-72W, Medium	Incand. Damp
NOH-8	8"	17"		53"	4 ¼" sq.		1-72W, Medium	Incand. Damp

NOC-6CS-RC

Frame: NOC-6
 Glass: Clear Seedy (CS)
 Finish: Raw Copper (RC)



NOC-8F-BZ

Frame: NOC-8
 Glass: Frosted (F)
 Finish: Bronze (BZ)

Specifications

Frame	Width	Height	Depth	Ext.	Mounting Base	Mounting Center to Top	Lamping	C-UL Rating
NOC-6	6"	14"			8" sq.		1-72W, Medium	Incand. Wet
NOC-8	8"	18"			10" sq.		1-72W Medium	Indand. Wet





OPB-7GW-BZ
 Frame: OPB-7
 Glass: Gold White Iridescent (GW)
 Finish: Bronze (BZ)



OPB-11GW-BZ
 Frame: OPB-11
 Glass: Gold White Iridescent (GW)
 Finish: Bronze (BZ)



OPB-9GW-BZ
 Frame: OPB-9
 Glass: Gold White Iridescent (GW)
 Finish: Bronze (BZ)

Specifications

Frame	Width	Height	Depth	Mounting Base	Mounting Center to Top	Lamping	C-UL Rating
OPB-7	7"	11"	8 ½"	4 ¼" x 6"	3"	1-100W, Medium	Incand. Wet
OPB-9	8 ½"	12 ½"	10"	4 ¼" x 7"	3 ½"	1-100W, Medium	Incand. Wet
OPB-11	10 ½"	15"	11 ½"	5" x 8"	4"	1-100W, Medium	Incand. Wet



OPH-7GW-RC

Frame: OPH-7
 Glass: Gold White Iridescent (GW)
 Finish: Raw Copper (RC)



OPH-9RM-MB

Frame: OPH-9
 Glass: Rain Mist (RM)
 Finish: Mission Brown (MB)



OPH-11OF-BZ

Frame: OPH-11
 Glass: Off White (OF)
 Finish: Bronze (BZ)

Specifications

Frame	Width	Height	Extension	Mounting Base	Lamping	C-UL Rating
OPH-7	7"	11"	47"	4 ¼"	1-100W, Medium	Incand. Damp
OPH-9	8 ½"	12 ½"	48 ½"	4 ¼"	1-100W, Medium	Incand. Damp
OPH-11	10 ½"	15"	51"	4 ¼"	1-100W, Medium	Incand. Damp



OPC-11WO-VP

Frame: OPC-11
Glass: White Opalescent (WO)
Finish: Verdigris Patina (VP)



OPC-15F-RB

Frame: OPC-15
Glass: Frosted (F)
Finish: Rustic Brown (RB)



OPP-9F-MB

Frame: OPP-9
Glass: Frosted (F)
Finish: Mission Brown (MB)



OPP-11F-MB

Frame: OPP-11
Glass: Frosted (F)
Finish: Mission Brown (MB)

Specifications

Frame	Width	Height	Mounting Base	Lamping	C-UL Rating
OPC-11	11"	5 ½"	9" sq.	2-60W, Medium	Incand. Wet
OPC-15	15"	6 ½"	12" sq.	2-60W, Medium	Incand. Wet
OPP-9	8 ½"	13 ½"		1-100W, Medium	Incand. Wet
OPP-11	10 ½"	16"		1-100W, Medium	Incand. Wet

Orpington

Wall Mounts & Pendants

ORB-8CS-BZ

Frame: ORB-8
Glass: Clear Seedy (CS)
Finish: Bronze (BZ)



ORB-10CS-BZ

Frame: ORB-10
Glass: Clear Seedy (CS)
Finish: Bronze (BZ)



ORH-10CS-P

Frame: ORH-10
Glass: Clear Seedy (CS)
Finish: Pewter (P)



ORH-8CLR-BK

Frame: ORH-8
Glass: Clear (CLR)
Finish: Satin Black (BK)

Specifications

Frame	Width	Height	Depth	Extension	Mounting Base	Mounting Center to Top	Lamping	C-UL Rating
ORB-8	7 5/8"	20"	7"		4" x 6"	8 3/4"	2-60W, Candle Clear	Incand. Wet
ORB-10	9 1/2"	25"	9"		5" x 7 1/2"	11"	2-60W, Candle Clear	Incand. Wet
ORH-8	7 5/8"	18"		54"	4 1/4" sq.		2-60W, Candle Clear	Incand. Damp
ORH-10	9 1/2"	22"		58"	4 1/4" sq.		2-60W, Candle Clear	Incand. Damp



PDB-9GRC-BZ

Frame: PDB-9
 Glass: Green-Red-Gold White
 Iridescent Combination (GRC)
 Finish: Bronze (BZ)



PDB-12GRC-BZ

Frame: PDB-12
 Glass: Green-Red-Gold White
 Iridescent Combination (GRC)
 Finish: Bronze (BZ)



PDB-17GRC-BZ

Frame: PDB-17
 Glass: Green-Red-Gold White
 Iridescent Combination (GRC)
 Finish: Bronze (BZ)

Specifications

Frame	Width	Height	Depth	Mounting Base	Mounting Center to Top	Lamping	C-UL Rating
PDB-9	9"	10"	12"	4" x 9"	5"	1-100W, Medium	Incand. Damp
PDB-12	12"	13"	14 1/2"	4 1/2" x 9"	7"	1-100W, Medium	Incand. Damp
PDB-17	17"	16"	20"	5" x 11"	7"	1-100W, Medium	Incand. Damp

Pagoda

Wall Mounts & Pendant



PDW-9GRC-BZ
 Frame: PDW-9
 Glass: Green-Red-Gold
 White Iridescent
 Combination (GRC)
 Finish: Bronze (BZ)



PDH-12GRC-RC
 Frame: PDH-12
 Glass: Green-Red-Gold White
 Iridescent Combination (GRC)
 Finish: Raw Copper (RC)



PDW-12GRC-BZ
 Frame: PDW-12
 Glass: Green-Red-Gold
 White Iridescent
 Combination (GRC)
 Finish: Bronze (BZ)



PDW-17GRC-BZ
 Frame: PDW-17
 Glass: Green-Red-Gold
 White Iridescent
 Combination (GRC)
 Finish: Bronze (BZ)

Specifications

Frame	Width	Height	Depth	Extension	Mounting Base	Mounting Center to Top	Lamping	C-UL Rating
PDH-12	12"	11"		49 ½"	4 ¼" sq.		1-100W, Medium	Incand. Damp
PDW-9	9"	6 7/8"	4 ½"			3 ½"	1-60W, Candle	Incand. Wet
PDW-12	12"	9"	6"			4 5/8"	1-60W, Candle	Incand. Wet
PDW-17	17"	12"	8 ½"			6"	1-100W, Medium	Incand. Wet

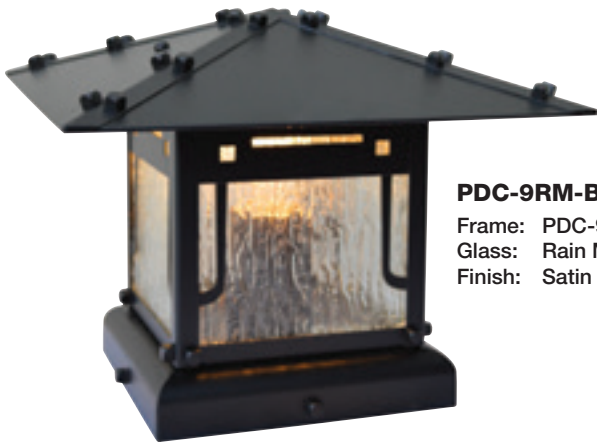

PDC-9RM-BK
 Frame: PDC-9
 Glass: Rain Mist (RM)
 Finish: Satin Black (BK)



PDC-12GRC-VP
 Frame: PDC-12
 Glass: Green-Red-Gold
 White Iridescent
 Combination (GRC)
 Finish: Verdigris Patina (VP)



PDC-17GW-MB
 Frame: PDC-17
 Glass: Gold White Iridescent (GW)
 Finish: Mission Brown (MB)



PDP-12GRC-RC
 Frame: PDP-12
 Glass: Green-Red-Gold
 White Iridescent
 Combination (GRC)
 Finish: Raw Copper (RC)

Specifications

Frame	Width	Height	Mounting Base	Lamping	C-UL Rating
PDC-9	9"	7 ½"	5 ½" sq.	1-100W, Medium	Incand. Wet
PDC-12	12"	9 ½"	7 ½" sq.	1-100W, Medium	Incand. Wet
PDC-17	17"	13"	10" sq.	1-100W, Medium	Incand. Wet
PDP-12	12"	8"		1-100W, Medium	Incand. Wet

Pasadena

A city noted for its classic arts and crafts bungalows; comforting homes with fine architectural details nestled amidst spreading golden oak trees.





PTL-16OGW-AB

Frame: PTL-16
 Overlay: Oak Tree Filigree (O)
 Glass: Gold White Iridescent (GW)
 Finish: Antique Brass (AB)



PTL-11OGW-AB

Frame: PTL-11
 Overlay: Oak Tree Filigree (O)
 Glass: Gold White Iridescent (GW)
 Finish: Antique Brass (AB)



PTL-9LCLGW-AB

Frame: PTL-9L
 Overlay: Cloud Lift (CL)
 Glass: Gold White Iridescent (GW)
 Finish: Antique Brass (AB)

Specifications

Frame	Width	Height	Mounting Base	Lamping	C-UL Rating
PTL-9L	9"	13 13/16"	7 1/2" sq.	1-60W, Medium	Incand. Dry
PTL-11	11"	16"	5 3/4" sq.	1-60W, Medium	Incand. Dry
PTL-16	16"	21 1/4"	8" sq.	4-60W, Medium	Incand. Dry

Overlay Design Options

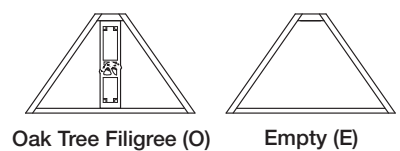

Pasadena

Wall Mounts & Ceiling Mounts



PIH-110GW-BZ

Frame: PIH-11
 Overlay: Oak Tree Filigree (O)
 Glass: Gold White Iridescent (GW)
 Finish: Bronze (BZ)

PIH-160GW-BZ

Frame: PIH-16
 Overlay: Oak Tree Filigree (O)
 Glass: Gold White Iridescent (GW)
 Finish: Bronze (BZ)



PSA-1EWO-VP

Frame: PSA-1
 Overlay: Empty (E)
 Glass: White Opalescent (WO)
 Finish: Verdigris Patina (VP)

Overlay Design Options

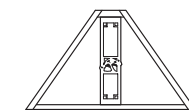

Oak Tree Filigree (O)

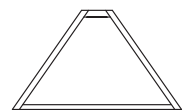

Empty (E)

Specifications

Frame	Width	Height	Depth	Mounting Base	Mounting Center to Top	Lamping	C-UL Rating
PIH-11	11"	10 7/8"		5" sq.		4-60W, Candle	Incand. Dry
PIH-16	16"	13"		5" sq.		4-60W, Medium	Incand. Dry
PSA-1	8 3/4"	13"	16 1/2"	4" x 8"	10 3/4"	1-60W, A15	Incand. Dry

Prairie

The Prairie series honors the design principles of Gustav Stickley and Frank Lloyd Wright with clean geometric lines, exposed structural details and attention to quality. It features lamp bases of quarter-sawn oak evocative of the period.





PFL-18GW-AB
 Frame: PFL-18
 Glass: Gold White Iridescent (GW)
 Finish: Antique Brass (AB)



PTL-12AM-BZ
 Frame: PTL-12
 Glass: Almond Mica (AM)
 Finish: Bronze (BZ)



PTL-15GW-VP
 Frame: PTL-15
 Glass: Gold White Iridescent (GW)
 Finish: Verdigris Patina (VP)

Specifications

Frame	Width	Height	Mounting Base	Lamping	C-UL Rating
PTL-12	13"	18 3/8"	7" sq.	1-60W, Medium	Incand. Dry
PTL-15	15 7/8"	23 1/8"	8 1/2" sq.	4-40W, Medium	Incand. Dry
PFL-18	19 5/8"	62 3/4"	12" sq.	4-40W, Medium	Incand. Dry



PS-12GW-BZ

Frame: PS-12
Glass: Gold White Iridescent (GW)
Finish: Bronze (BZ)



PS-15WO-RC

Frame: PS-15
Glass: White Opalescent (WO)
Finish: Raw Copper (RC)

Specifications

Frame	Width	Height	Depth	Mounting Center to Top	Lamping	C-UL Rating
PS-12	12"	6 5/8"	6"	2 3/4"	2-60W, Medium	Incand. Dry
PS-15	15"	8 1/8"	7 1/2"	3 3/4"	2-60W, Medium	Incand. Dry

PIH-12GW-AB

Frame: PIH-12
Glass: Gold White Iridescent (GW)
Finish: Antique Brass (AB)



PIH-18GW-AB

Frame: PIH-18
Glass: Gold White Iridescent (GW)
Finish: Antique Brass (AB)



PIH-15GW-AB

Frame: PIH-15
Glass: Gold White Iridescent (GW)
Finish: Antique Brass (AB)

Specifications

Frame	Width	Height	Mounting Base	Lamping	C-UL Rating
PIH-12	12"	10 3/8"	5 1/4" sq.	4-60W, Candle	Incand. Dry
PIH-15	15"	15 3/8"	5 1/4" sq.	4-60W, Medium	Incand. Dry
PIH-18	18 1/8"	17 1/2"	6 1/4" sq.	4-60W, Medium	Incand. Dry

PH-12M-BZ

Frame: PH-12
Glass: Amber Mica (M)
Finish: Bronze (BZ)



PH-15M-BZ

Frame: PH-15
Glass: Amber Mica (M)
Finish: Bronze (BZ)



PH-18OF-MB

Frame: PH-18
Glass: Off White (OF)
Finish: Mission Brown (MB)

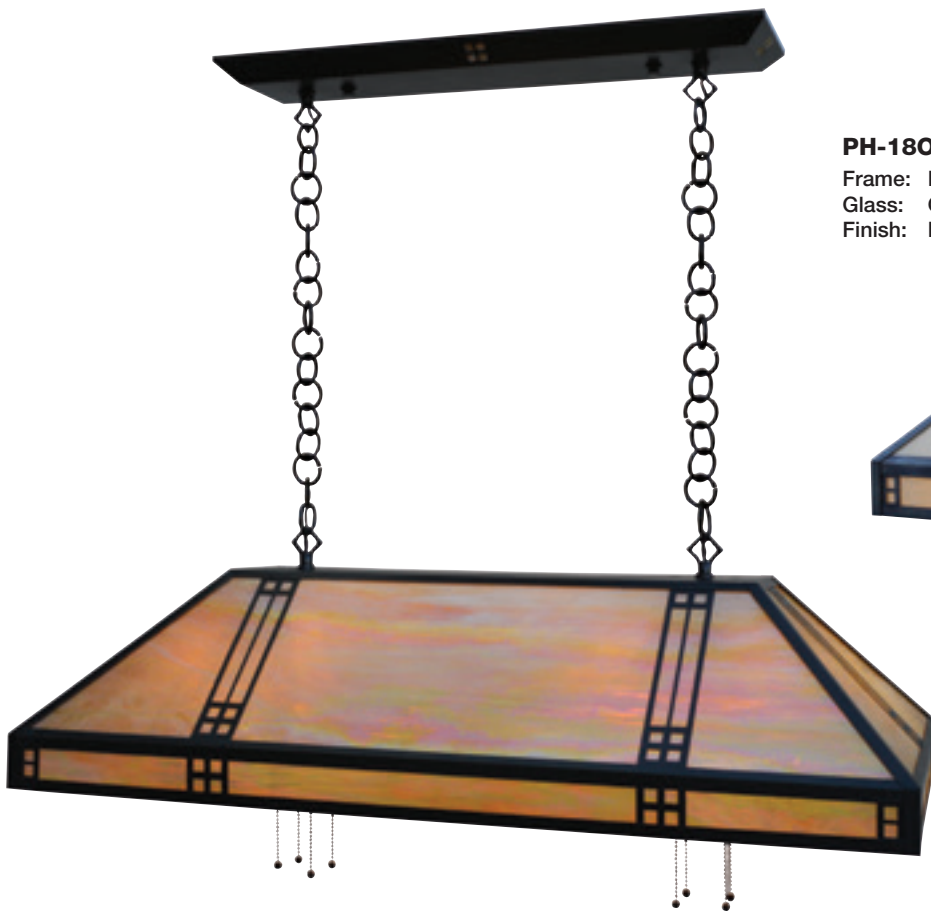

PH-18/36GW-BZ

Frame: PH-18/36
Glass: Gold White Iridescent (GW)
Finish: Bronze (BZ)

Specifications

Frame	Width	Height	Extension	Mounting Base	Lamping	C-UL Rating
PH-12	12"	7 ⁷ / ₈ "	43 ⁷ / ₈ "	5 ¹ / ₄ " sq.	1-100W, Medium	Incand. Dry
PH-15	15"	10 ³ / ₈ "	46 ³ / ₈ "	5 ¹ / ₄ " sq.	4-40W, Medium	Incand. Dry
PH-18	18 ¹ / ₈ "	12"	48"	5 ¹ / ₄ " sq.	4-60W, Medium	Incand. Dry
PH-18/36	36"	10 ⁷ / ₈ "	46 ⁷ / ₈ "	6 ¹ / ₄ " x 24 ¹ / ₄ "	8-40W, Medium	Incand. Dry



PSH-12CR-MB
 Frame: PSH-12
 Glass: Cream (CR)
 Finish: Mission Brown (MB)



PSH-15GW-RC
 Frame: PSH-15
 Glass: Gold White Iridescent (GW)
 Finish: Raw Copper (RC)



PSH-18OF-VP
 Frame: PSH-18
 Glass: Off White (OF)
 Finish: Verdigris Patina (VP)

Specifications

Frame	Width	Height	Extension	Mounting Base	Lamping	C-UL Rating
PSH-12	12"	7 7/8"	38 1/2"	5 1/4" sq.	1-100W, Medium	Incand. Dry
PSH-15	15"	10 3/8"	41"	5 1/4" sq.	4-40W, Medium	Incand. Dry
PSH-18	18 1/8"	12"	43 5/8"	5 1/4" sq.	4-60W, Medium	Incand. Dry



PCH-18WO-AC

Frame: PCH-18
 Glass: White Opalescent (WO)
 Finish: Antique Copper (AC)



PCH-36WO-AC

Frame: PCH-36
 Glass: White Opalescent (WO)
 Finish: Antique Copper (AC)

Specifications

Frame	Width	Height	Extension	Mounting Base	Lamping	C-UL Rating
PCH-18	18 1/8"	10 5/8"	31 1/2"	6 1/4" sq.	4-60W, Medium	Incand. Dry
PCH-36	36"	16 3/4"	36"	8" sq.	8-60W, Medium	Incand. Dry



PRW-7CS-BK

Frame: PRW-7
Glass: Clear Seedy (CS)
Finish: Satin Black (BK)



PRW-7LCS-MB

Frame: PRW-7L
Glass: Clear Seedy (CS)
Finish: Mission Brown (MB)



PRW-9CS-MB

Frame: PRW-9
Glass: Clear Seedy (CS)
Finish: Mission Brown (MB)



PRC-15CS-BZ

Frame: PRC-15
Glass: Clear Seedy (CS)
Finish: Bronze (BZ)

Specifications

Frame	Width	Height	Depth	Mounting Base	Mounting Center to Top	Lamping	C-UL Rating
PRC-15	15"	11"		15" sq.		4-60W, Candle Clear	Incand. Wet
PRW-7	7"	14"	7 1/2"	5 1/2" x 5"	7 1/2"	2-60W, Candle Clear	Incand. Wet
PRW-7L	7"	19"	7 1/2"	5 1/2" x 5"	7 1/2"	2-60W, Candle Clear	Incand. Wet
PRW-9	9"	24"	9 1/2"	7 1/2" x 7"	9 1/4"	2-60W, Candle Clear	Incand. Wet





RB-6M-AC
 Frame: RB-6
 Glass: Amber Mica (M)
 Finish: Antique Copper (AC)



RB-8M-AC
 Frame: RB-8
 Glass: Amber Mica (M)
 Finish: Antique Copper (AC)



RB-10M-AC
 Frame: RB-10
 Glass: Amber Mica (M)
 Finish: Antique Copper (AC)

Specifications

Frame	Width	Height	Depth	Mounting Base	Mounting Center to Top	Lamping	C-UL Rating
RB-6	5 ¼"	10 ½"	8"	5" sq.	2 ½"	1-100W, Medium	Incand. Damp
RB-8	8"	19"	12"	6 ½" sq.	3 ¼"	1-100W, Medium	Incand. Damp
RB-10	9 ⅞"	21 ¾"	13 ⅜"	6 ½" sq.	3 ¼"	1-100W, Medium	Incand. Damp



RB-6WWO-BZ

Frame: RB-6W
 Glass: White Opalescent (WO)
 Finish: Bronze (BZ)



RB-8WWO-BZ

Frame: RB-8W
 Glass: White Opalescent (WO)
 Finish: Bronze (BZ)



RB-10WWO-BZ

Frame: RB-10W
 Glass: White Opalescent (WO)
 Finish: Bronze (BZ)

Specifications

Frame	Width	Height	Depth	Mounting Base	Mounting Center to Top	Lamping	C-UL Rating
RB-6W	5 ¼"	10 ¾"	7 ⅞"	5" sq.	2 ½"	1-100W, Medium	Incand. Wet
RB-8W	8"	14 ¾"	11 ⅞"	6 ½" sq.	3 ¼"	1-100W, Medium	Incand. Wet
RB-10W	9 ⅞"	17 ½"	14"	6 ½" sq.	3 ¼"	1-100W, Medium	Incand. Wet



RH-6F-RC

Frame: RH-6
 Glass: Frosted (F)
 Finish: Raw Copper (RC)



RH-8WO-BK

Frame: RH-8
 Glass: White Opalescent (WO)
 Finish: Satin Black (BK)



RH-10GW-VP

Frame: RH-10
 Glass: Gold White Iridescent (GW)
 Finish: Verdigris Patina (VP)

Specifications

Frame	Width	Height	Extension	Mounting Base	Lamping	C-UL Rating
RH-6	5 ¼"	8 7/8"	44 7/8"	4 ¼" sq.	1-100W, Medium	Incand. Damp
RH-8	8"	12 ¾"	48 ¾"	4 ¼" sq.	1-100W, Medium	Incand. Damp
RH-10	9 7/8"	15 ½"	51 ½"	4 ¼" sq.	1-100W, Medium	Incand. Damp



RS-2-P
BG-FCE

Frame: RS-2
Glass: Frosted Curved (BG-FCE)*
Finish: Pewter (P)



RS-1-AB
BG-FST

Frame: RS-1
Glass: Frosted (BG-FST)*
Finish: Antique Brass (AB)



RS-3-BZ
BG-FST

Frame: RS-3
Glass: Frosted (FST)
Finish: Bronze (BZ)

RB-1-RC
BG-STS

Frame: RB-1
Glass: Stratus (BG-STS)*
Finish: Raw Copper (RC)



Art Glass Shade Options



BG-FST
Frosted

BG-FCE
Frosted Curved
Edge

BG-STS
Stratus

BG-MUS
Mustard

Specifications

Frame	Width	Height	Depth	Mounting Base	Mounting Center to Top	Lamping	C-UL Rating
RB-1	5"	9"	7 3/4"	4" x 6"	4 3/4"	1-60W, A15	Incand. Damp
RS-1	5"	9 3/4"	8"	5" sq.	2 1/2"	1-60W, A15	Incand. Damp**
RS-2	13"	9 3/4"	8"	5" sq.	2 1/2"	2-60W, A15	Incand. Damp**
RS-3	21"	9 3/4"	8"	5" sq.	2 1/2"	3-60W, A15	Incand. Damp**

Dimensions may change depending on glass chosen.

*Glass shades sold separately.

**Damp rated with shades down.



**RH-1-BZ
BG-FST**
Frame: RH-1
Glass: Frosted (BG-FST)*
Finish: Bronze (BZ)



**RCH-4-BK
BG-ST**
Frame: RCH-4
Glass: Stratus (BG-ST)*
Finish: Satin Black (BK)



**RSH-1-BZ
BG-MUS**
Frame: RSH-1
Glass: Mustard (BG-MUS)*
Finish: Bronze (BZ)

**RCH-4U-BZ
BG-MUS**
Frame: RCH-4U
Glass: Mustard (BG-MUS)*
Finish: Bronze (BZ)



Art Glass Shade Options



BG-FST Frosted BG-FCE Frosted Curved Edge BG-ST Stratus BG-MUS Mustard

Specifications

Frame	Width	Height	Extension	Mounting Base	Lamping	C-UL Rating
RH-1	5"	7 7/8"	43 7/8"	4 1/4" sq.	1-60W, A15	Incand. Damp
RSH-1	5"	6 3/4"	29 3/4"	4 1/4" sq.	1-60W, A15	Incand. Damp
RCH-4	29 3/8"	23"	60 3/4"	4 1/4" sq.	4-60W, A15	Incand. Dry
RCH-4U	29 3/8"	22 1/2"	60 1/4"	4 1/4" sq.	4-60W, A15	Incand. Dry

Dimensions may change depending on glass chosen.
*Glass shades sold separately.

**RCM-4-BK
BG-ST5**
Frame: RCM-4
Glass: Stratus (BG-ST5)*
Finish: Satin Black (BK)



**RCM-1-AB
BG-ST5**
Frame: RCM-1
Glass: Stratus (BG-ST5)*
Finish: Antique Brass (AB)



**RCM-2-AB
BG-ST5**
Frame: RCM-2
Glass: Stratus (BG-ST5)*
Finish: Antique Brass (AB)



Art Glass Shade Options



BG-FST
Frosted

BG-FCE
Frosted Curved
Edge

BG-ST5
Stratus

BG-MUS
Mustard

Specifications

Frame	Width	Height	Mounting Base	Lamping	C-UL Rating
RCM-1	5"	10 1/4"	4 1/4" sq.	1-60W, A15	Incand. Dry
RCM-2	15"	10 3/8"	4 1/2" x 14"	2-60W, A15	Incand. Dry
RCM-4	16"	10 3/8"	15" sq.	4-60W, A15	Incand. Dry

Dimensions may change depending on glass chosen.

*Glass shades sold separately.

SCW-16GWC-VP

Frame: SCW-16
 Glass: Gold White Iridescent-White
 Opalescent Combination (GWC)
 Finish: Verdigris Patina (VP)



SCW-12GWC-VP

Frame: SCW-12
 Glass: Gold White Iridescent-White
 Opalescent Combination (GWC)
 Finish: Verdigris Patina (VP)



Specifications

Frame	Width	Height	Depth	Mounting Base	Mounting Center to Top	Lamping	C-UL Rating
SCW-12	7 5/8"	12"	5 1/2"	4 1/2" x 10 1/2"	6"	1-100W, Medium	Incand. Wet
SCW-16	7 5/8"	16"	5 1/2"	4 1/2" x 14 1/2"	8"	1-100W, Medium	Incand. Wet

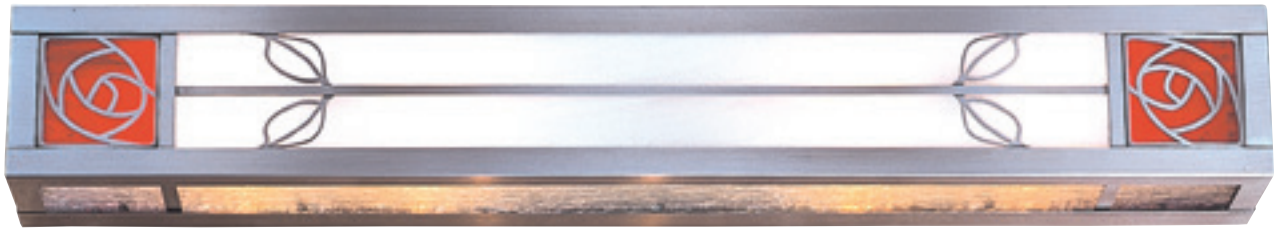

SCLB-30REC-P

Frame: SCLB-30
 Glass: Red-White Opalescent Combination (REC)
 Finish: Pewter (P)

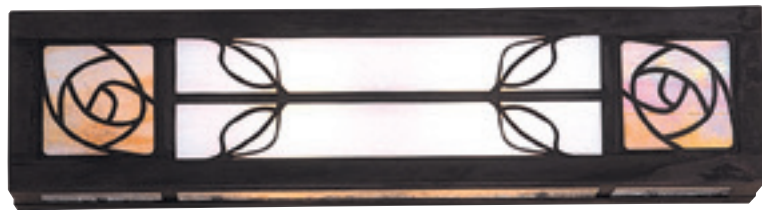

SCLB-18GWC-BZ

Frame: SCLB-18
 Glass: Gold White Iridescent-White
 Opalescent Combination (GWC)
 Finish: Bronze (BZ)



SCH-12BC-P

Frame: SCH-12
 Glass: Blue-White Opalescent
 Combination (BC)
 Finish: Pewter (P)

Specifications

Frame	Width	Height	Depth	Mounting Base	Mounting Center to Top	Lamping	C-UL Rating
SCLB-18	18"	4 ¼"	4"	4 ¼" x 18"	2"	2-60W, T10	Incand. Damp
SCLB-30	30"	4 ¼"	4"	4 ¼" x 30"	2"	4-60W, T10	Incand. Damp
SCH-12	8"	14 ⅜"	50 ⅜"	5" sq.	1-100W, Medium	Incand. Damp	

SCCH-21GWC-BZ

Frame: SCCH-21
 Glass: Gold White Iridescent-White
 Opalescent Combination (GWC)
 Finish: Bronze (BZ)



SCCM-15GWC-AB

Frame: SCCM-15
 Glass: Gold White Iridescent-White
 Opalescent Combination (GWC)
 Finish: Antique Brass (AB)



SCCM-21CR-BZ

Frame: SCCM-21
 Glass: Cream (CR)
 Finish: Bronze (BZ)



Specifications

Frame	Width	Height	Extension	Mounting Base	Lamping	C-UL Rating
SCCH-21	21 1/2"	24 7/8"	60 7/8"	5" sq.	4-100W, Medium	Incand. Dry
SCCM-15	15 1/2"	10 3/4"		5" sq.	2-60W, Medium	Incand. Dry
SCCM-21	21 1/2"	11 1/4"		5" sq.	4-100W, Medium	Incand. Dry

Saint George

These Carpenter-Gothic inspired pieces emphasize a return to individual craftsmanship with the use of fanciful details such as steeply pitched roofs and lancet arches.





SGH-7M-RC
 Frame: SGH-7
 Glass: Amber Mica (M)
 Finish: Raw Copper (RC)



SGH-10TN-BZ
 Frame: SGH-10
 Glass: Tan (TN)
 Finish: Bronze (BZ)



SGCH-20GW-BZ
 Frame: SGCH-20
 Glass: Gold White Iridescent (GW)
 Finish: Bronze (BZ)

Specifications

Frame	Width	Height	Extension	Mounting Base	Lamping	C-UL Rating
SGH-7	7"	17"	53"	5" x 5"	1-100W, Medium	Incand. Damp
SGH-10	10"	24 ½"	60 ½"	5" x 5"	1-100W, Medium	Incand. Damp
SGCH-20	20"	26 ¼"	62 ¼"	5" x 5"	4-100W, Medium	Incand. Dry

Saint George

Wall Mounts, Column & Post Mount



SGB-7WO-RC
 Frame: SGB-7
 Glass: White Opalescent (WO)
 Finish: Raw Copper (RC)



SGB-10WO-RC
 Frame: SGB-10
 Glass: White Opalescent (WO)
 Finish: Raw Copper (RC)



SGC-10RM-VP
 Frame: SGC-10
 Glass: Rain Mist (RM)
 Finish: Verdigris Patina (VP)

SGP-10OF-BZ
 Frame: SGP-10
 Glass: Off White (OF)
 Finish: Bronze (BZ)



Specifications

Frame	Width	Height	Depth	Mounting Base	Mounting Center to Top	Lamping	C-UL Rating
SGB-7	7"	17 3/4"	10 3/8"	4 1/4" x 9 1/4"	11 7/16"	1-100W, Medium	Incand. Wet
SGB-10	10"	24 1/2"	12"	4 1/4" x 9 1/4"	11 7/16"	1-100W, Medium	Incand. Wet
SGC-10	10"	23 3/4"		10" sq.		1-100W, Medium	Incand. Wet
SGP-10	10"	23 1/2"				1-100W, Medium	Incand. Wet

Santorini

Wall Mounts & Pendant and Post Mount



SAH-9DD-RC

Frame: SAH-9
Glass: Dew Drop (DD)
Finish: Raw Copper (RC)



SAP-9DD-RC

Frame: SAP-9
Glass: Dew Drop (DD)
Finish: Raw Copper (RC)



SAB-7DD-RC

Frame: SAB-7
Glass: Dew Drop (DD)
Finish: Raw Copper (RC)



SAB-9DD-RC

Frame: SAB-9
Glass: Dew Drop (DD)
Finish: Raw Copper (RC)

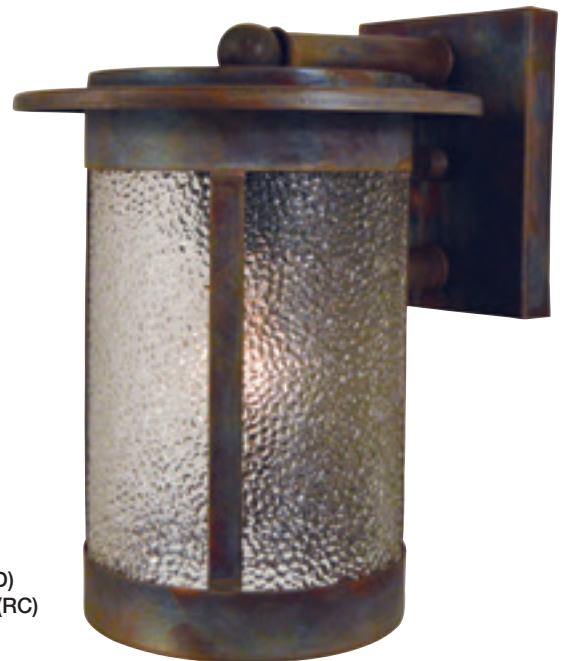

SAB-11DD-RC

Frame: SAB-11
Glass: Dew Drop (DD)
Finish: Raw Copper (RC)

Specifications

Frame	Width	Height	Depth	Extension	Mounting Base	Mounting Center to Top	Lamping	C-UL Rating
SAB-7	7"	10"	8"		4" x 5"	2 1/2"	1-100W, Medium	Incand. Wet
SAB-9	9"	13"	10"		4" x 6"	3"	1-100W, Medium	Incand. Wet
SAB-11	11"	16"	12 1/2"		5" x 8"	4"	1-100W, Medium	Incand. Wet
SAH-9	9"	14"		50"	5" round		1-100W, Medium	Incand. Damp
SAP-9	9"	13"					1-100W, Medium	Incand. Wet



SDB-6GW-VP

Frame: SDB-6
Glass: Gold White Iridescent (GW)
Finish: Verdigris Patina (VP)



SDB-10WO-VP

Frame: SDB-10
Glass: White Opalescent (WO)
Finish: Verdigris Patina (VP)



SDCM-13CS-BZ

Frame: SDCM-13
Glass: Clear Seedy (CS)
Finish: Bronze (BZ)

SDC-13F-BZ

Frame: SDC-13
Glass: Frosted (F)
Finish: Bronze (BZ)



Specifications

Frame	Width	Height	Depth	Mounting Base	Mounting Center to Top	Lamping	C-UL Rating
SDB-6	6"	14"	8"	4" x 6"	7"	1-100W, Medium	Incand. Wet
SDB-10	10"	21"	11"	5" x 8"	10 ½"	1-100W, Medium	Incand. Wet
SDCM-13	13"	7"		15" sq.		2-60W, Medium	Incand. Damp
SDC-13	13"	7"		15" sq.		2-60W, Medium	Incand. Wet

Simplicity

Wall Mounts

Art Glass Shade Options



BG-WHT
White



BG-GLD
Gold Lustré



BG-MAG
Magnolia



SLB-2-AB BG-WHT

Frame: SLB-2
Glass: White (BG-WHT)*
Finish: Antique Brass (AB)

SLB-3-P BG-WHT

Frame: SLB-3
Glass: White (BG-WHT)*
Finish: Pewter (P)



SLB-4-BZ BG-WHT

Frame: SLB-4
Glass: White (BG-WHT)*
Finish: Bronze (BZ)

Specifications

Frame	Width	Height	Depth	Mounting Base	Mounting Center to Top	Lamping	C-UL Rating
SLB-2	14"	8 ¼"	6 ½"	4 ½" x 14"	2 ¼"	2-60W, A15	Incand. Damp**
SLB-3	24"	8 ¼"	6 ½"	4 ½" x 24"	2 ¼"	3-60W, A15	Incand. Damp**
SLB-4	36"	8 ¼"	6 ½"	4 ½" x 36"	2 ¼"	4-60W, A15	Incand. Damp**

Dimensions may change depending on glass chosen.

*Glass shades sold separately.

**Damp rated with shades down.

Simplicity

Wall Mounts & Pendants



SB-1-MB
BG-WHT
Frame: SB-1
Glass: White (BG-WHT)*
Finish: Mission Brown (MB)



SSH-1-BZ
BG-WHT
Frame: SSH-1
Glass: White (BG-WHT)*
Finish: Bronze (BZ)



SS-1-VP
BG-GLD
Frame: SS-1
Glass: Gold Lustre (BG-GLD)*
Finish: Verdigris Patina (VP)



SH-1-AB
BG-WHT
Frame: SH-1
Glass: White (BG-WHT)*
Finish: Antique Brass (AB)

Art Glass Shade Options



BG-WHT
White



BG-GLD
Gold Lustre



BG-MAG
Magnolia

Specifications

Frame	Width	Height	Depth	Extension	Mounting Base	Mounting Center to Top	Lamping	C-UL Rating
SB-1	4"	9"	7 1/4"		4" x 6"	4 3/4"	1-60W, A15	Incand. Damp
SH-1	4"	7 7/8"		43 7/8"	4 1/4" sq.		1-60W, A15	Incand. Dry
SS-1	4"	8 1/4"	6 1/4"		4" x 6"	3"	1-60W, A15	Incand. Dry
SSH-1	4"	6 3/4"		29 7/8"	4 1/4" sq.		1-60W, A15	Incand. Damp

Dimensions may change depending on glass chosen.

*Glass shades sold separately.



SYW-7DD-RC

Frame: SYW-7
Glass: Dew Drop (DD)
Finish: Raw Copper (RC)



SYH-12AE-BZ

Frame: SYH-12
Glass: Aerolite (AE)
Finish: Bronze (BZ)



SYW-7LAE-BZ

Frame: SYW-7L
Glass: Aerolite (AE)
Finish: Bronze (BZ)



SYW-9CLR-BK

Frame: SYW-9
Glass: Clear (CLR)
Finish: Satin Black (BK)

Specifications

Frame	Width	Height	Depth	Extension	Mounting Base	Mounting Center to Top	Lamping	C-UL Rating
SYW-7	7"	12"	7 1/2"		5" x 6"	5 3/4"	1-100W, Medium	Incand. Wet
SYW-7L	7"	18"	7 1/2"		6" x 6"	6"	2-60W, Candle Clear	Incand. Wet
SYW-9	9"	23 1/2"	9 1/2"		8" x 9"	8 1/2"	2-60W, Candle Clear	Incand. Wet
SYH-12	12"	18"		54"	4 1/4" sq.		4-60W, Candle Clear	Incand. Damp



Timber Ridge

Wall Mounts



TRB-9MNGW-BZ

Frame: TRB-9
 Overlay: Mountain (MN)
 Glass: Gold White Iridescent (GW)
 Finish: Bronze (BZ)



TRB-12ARGW-VP

Frame: TRB-12
 Overlay: Arrowhead (AR)
 Glass: Gold White Iridescent (GW)
 Finish: Verdigris Patina (VP)



TRB-16DRGW-BZ

Frame: TRB-16
 Overlay: Deer (DR)
 Glass: Gold White Iridescent (GW)
 Finish: Bronze (BZ)

Specifications

Frame	Width	Height	Depth	Mounting Base	Mounting Center to Top	Lamping	C-UL Rating
TRB-9	9"	13"	12"	4 1/2" x 9"	5"	1-100W, Medium	Incand. Damp
TRB-12	12"	15"	14 1/2"	5" x 11"	7"	1-100W, Medium	Incand. Damp
TRB-16	16"	19 1/2"	19 1/2"	5" x 11"	7"	1-100W, Medium	Incand. Damp

Timber Ridge

Pendants



TRH-9TRTN-BZ
 Frame: TRH-9
 Overlay: Trout (TR)
 Glass: Tan (TN)
 Finish: Bronze (BZ)

TRH-12ARGW-VP
 Frame: TRH-12
 Overlay: Arrowhead (AR)
 Glass: Gold White Iridescent (GW)
 Finish: Verdigris Patina (VP)



TRH-16PTGW-VP
 Frame: TRH-16
 Overlay: Palm Tree (PT)
 Glass: Gold White Iridescent (GW)
 Finish: Verdigris Patina (VP)



Overlay Design Options

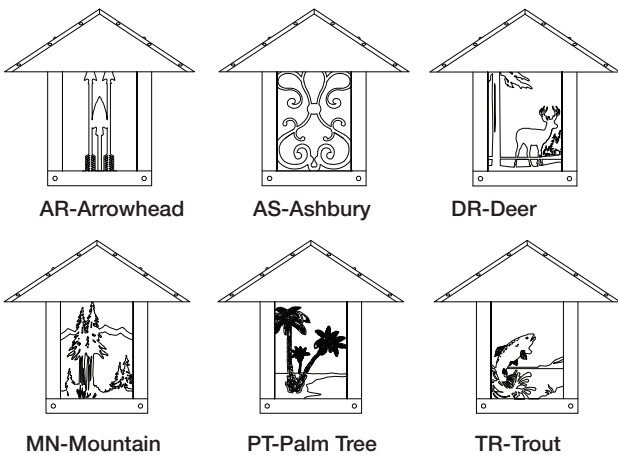

Specifications

Frame	Width	Height	Extension	Mounting Base	Lamping	C-UL Rating
TRH-9	9"	12"	48"	4 1/4" sq.	1-100W, Medium	Incand. Damp
TRH-12	12"	13 1/2"	49 1/2"	4 1/4" sq.	1-100W, Medium	Incand. Damp
TRH-16	16"	17 1/2"	53 1/2"	4 1/4" sq.	1-100W, Medium	Incand. Damp



TRC-9MNGW-RC
 Frame: TRC-9
 Overlay: Mountain (MN)
 Glass: Gold White Iridescent (GW)
 Finish: Raw Copper (RC)



TRC-12DRWO-RC
 Frame: TRC-12
 Overlay: Deer (DR)
 Glass: White Opalescent (WO)
 Finish: Raw Copper (RC)



TRC-16ASWO-RC
 Frame: TRC-16
 Overlay: Ashbury (AS)
 Glass: White Opalescent (WO)
 Finish: Raw Copper (RC)

Specifications

Frame	Width	Height	Mounting Base	Lamping	C-UL Rating
TRC-9	9"	11"	7" sq.	1-100W, Medium	Incand. Wet
TRC-12	12"	13"	8" sq.	1-100W, Medium	Incand. Wet
TRC-16	16"	16"	9 ½" sq.	1-100W, Medium	Incand. Wet

Timber Ridge

Post Mounts



TRP-9TRTN-BZ

Frame: TRP-9
 Overlay: Trout (TR)
 Glass: Tan (TN)
 Finish: Bronze (BZ)



TRP-12ARGW-VP

Frame: TRP-12
 Overlay: Arrowhead (AR)
 Glass: Gold White Iridescent (GW)
 Finish: Verdigris Patina (VP)



TRP-16PTGW-RC

Frame: TRP-16
 Overlay: Palm Tree (PT)
 Glass: Gold White Iridescent (GW)
 Finish: Raw Copper (RC)

Overlay Design Options

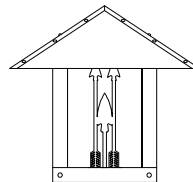

AR-Arrowhead

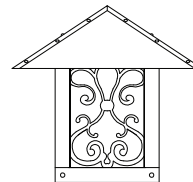

AS-Ashbury

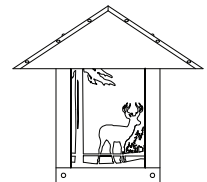

DR-Deer

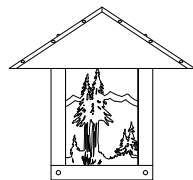

MN-Mountain

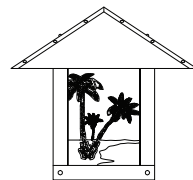

PT-Palm Tree

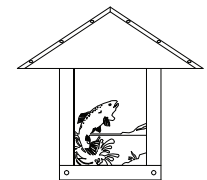

TR-Trout

Specifications

Frame	Width	Height	Lamping	C-UL Rating
TRP-9	9"	10"	1-100W, Medium	Incand. Wet
TRP-12	12"	12"	1-100W, Medium	Incand. Wet
TRP-16	16"	15"	1-100W, Medium	Incand. Wet

Valencia

A style inspired by the 18th and 19th Spanish colonial missions along the California coast from San Deigo de Alcalá to San Francisco Solano.





VB-7RM-RC
 Frame: VB-7
 Glass: Rain Mist (RM)
 Finish: Raw Copper (RC)



VB-9RM-RC
 Frame: VB-9
 Glass: Rain Mist (RM)
 Finish: Raw Copper (RC)



VB-11RM-RC
 Frame: VB-11
 Glass: Rain Mist (RM)
 Finish: Raw Copper (RC)



VB-7NRM-MB
 Frame: VB-7NR
 Glass: Amber mica (M)
 Finish: Mission Brown (MB)



VB-9NRM-MB
 Frame: VB-9NR
 Glass: Amber mica (M)
 Finish: Mission Brown (MB)



VB-11NRM-MB
 Frame: VB-11NR
 Glass: Amber mica (M)
 Finish: Mission Brown (MB)

Specifications

Frame	Width	Height	Depth	Mounting Base	Mounting Center to Top	Lamping	C-UL Rating
VB-7	7 ¼"	18 ½"	11"	4" x 8 ½"	5 ⅝"	1-60W, Medium	Incand. Damp
VB-9	9 ¼"	23 ½"	13"	5" x 11"	7"	1-100W, Medium	Incand. Damp
VB-11	11 ¼"	28 ⅝"	17 ¼"	6" x 15"	8 ¼"	1-100W, Medium	Incand. Damp
VB-7NR	5 ⅝"	13"	9 ⅜"	4" x 8 ½"	5 ⅝"	1-100W, Medium	Incand. Damp
VB-9NR	6 ¼"	16 ½"	11 ½"	5" x 11"	7"	1-100W, Medium	Incand. Damp
VB-11NR	7 ⅝"	20 ⅛"	15 ⅝"	6" x 15"	8 ¼"	1-100W, Medium	Incand. Damp



VS-7CS-BK

Frame: VS-7
Glass: Clear Seedy (CS)
Finish: Satin Black (BK)



VS-9CS-BK

Frame: VS-9
Glass: Clear Seedy (CS)
Finish: Satin Black (BK)



VS-11CS-BK

Frame: VS-11
Glass: Clear Seedy (CS)
Finish: Satin Black (BK)



VS-7NRRM-RB

Frame: VS-7NR
Glass: Rain Mist (RM)
Finish: Rustic Brown (RB)



VS-9NRRM-RB

Frame: VS-9NR
Glass: Rain Mist (RM)
Finish: Rustic Brown (RB)



VS-11NRRM-RB

Frame: VS-11NR
Glass: Rain Mist (RM)
Finish: Rustic Brown (RB)

Specifications

Frame	Width	Height	Depth	Mounting Base	Mounting Center to Top	Lamping	C-UL Rating
VS-7	7 ¼"	15 ⅝"	9 ⅜"	4" x 8 ½"	10 13/16"	1-60W, Medium	Incand. Wet
VS-9	9 ¼"	19 ¼"	11"	5" x 11"	13 ⅜"	1-100W, Medium	Incand. Wet
VS-11	11 ¼"	23 ⅝"	12 ¾"	5" x 11"	16 ¾"	1-100W, Medium	Incand. Wet
VS-7NR	5 ⅞"	9 ½"	8 ¼"	4" x 8 ½"	4 ¾"	1-100W, Medium	Incand. Dry
VS-9NR	6 ¼"	11 ¾"	9 ½"	5" x 11"	5 7/8"	1-100W, Medium	Incand. Dry
VS-11NR	7 ⅝"	14 ¼"	11"	5" x 11"	7 1/8"	1-100W, Medium	Incand. Dry



VCH-7/5RM-BK

Frame: VCH-7/5
 Glass: Rain Mist (RM)
 Finish: Satin Black (BK)

VH-7CS-BZ

Frame: VH-7
 Glass: Clear Seedy (CS)
 Finish: Bronze (BZ)

Specifications

Frame	Width	Overall Width	Height	Extension	Mounting Base	Lamping	C-UL Rating
VCH-7/5	7 1/4"	32"	34"	70"	5" sq.	5-60W, Medium	Incand. Dry
VH-7	7 1/4"		17 3/8"	53 3/8"	5" sq.	1-60W, Medium	Incand. Damp



VH-7NRM-BK
 Frame: VH-7NR
 Glass: Amber Mica (M)
 Finish: Satin Black (BK)



VH-9NRM-BK
 Frame: VH-9NR
 Glass: Amber Mica (M)
 Finish: Satin Black (BK)



VH-11NRM-BK
 Frame: VH-11NR
 Glass: Amber Mica (M)
 Finish: Satin Black (BK)



VSH-7NRM-BK
 Frame: VSH-7NR
 Glass: Amber Mica (M)
 Finish: Satin Black (BK)



VSH-9NRM-BK
 Frame: VSH-9NR
 Glass: Amber Mica (M)
 Finish: Satin Black (BK)

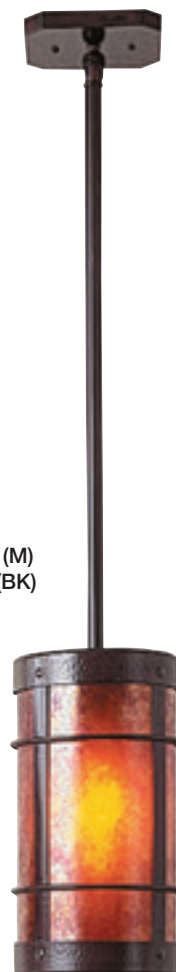

VSH-11NRM-BK
 Frame: VSH-11NR
 Glass: Amber Mica (M)
 Finish: Satin Black (BK)

Specifications

Frame	Width	Height	Extension	Mounting Base	Lamping	C-UL Rating
VH-7NR	5 1/8"	11 7/8"	47 1/4"	5" sq.	1-100W, Medium	Incand. Damp
VH-9NR	6 1/4"	15"	51"	5" sq.	1-100W, Medium	Incand. Damp
VH-11NR	7 5/8"	17 3/4"	53 3/4"	5" sq.	1-100W, Medium	Incand. Damp
VSH-7NR	5 1/8"	9 1/2"	32 5/8"	5" sq.	1-100W, Medium	Incand. Wet
VSH-9NR	6 1/4"	11 3/4"	35"	5" sq.	1-100W, Medium	Incand. Wet
VSH-11NR	7 5/8"	14 1/4"	37 1/2"	5" sq.	1-100W, Medium	Incand. Wet

VIB-6LCLR-BZ

Frame: VIB-6L
Glass: Clear (CLR)
Finish: Bronze (BZ)



VIB-5F-BZ

Frame: VIB-5
Glass: Frosted (F)
Finish: Bronze (BZ)



VIB-6TLF-BZ

Frame: VIB-6TL
Glass: Frosted (F)
Finish: Bronze (BZ)



VIB-9CLR-BZ

Frame: VIB-9
Glass: Clear (CLR)
Finish: Bronze (BZ)



Specifications

Frame	Width	Height	Depth	Mounting Base	Mounting Center to Top	Lamping	C-UL Rating
VIB-5	5"	10 ¼"	6 ½"	4" x 6"	3"	1-100W, Medium	Incand. Wet
VIB-6L	6"	17 ¼"	7 ½"	5" x 8"	4"	1-100W, Medium	Incand. Wet
VIB-6TL	6"	21 ¼"	7 ½"	5" x 10"	5"	1-100W, Medium	Incand. Wet
VIB-9	9"	29 ½"	11 ½"	5" x 12"	6"	1-100W, Medium	Incand. Wet

VIS-4CLR-BZ

Frame: VIS-4
Glass: Clear (CLR)
Finish: Bronze (BZ)



VIS-7CLR-BZ

Frame: VIS-7
Glass: Clear (CLR)
Finish: Bronze (BZ)



VIS-8CLR-BZ

Frame: VIS-8
Glass: Clear (CLR)
Finish: Bronze (BZ)



VIS-10CLR-BZ

Frame: VIS-10
Glass: Clear (CLR)
Finish: Bronze (BZ)



VIS-12CLR-BZ

Frame: VIS-12
Glass: Clear (CLR)
Finish: Bronze (BZ)

Specifications

Frame	Width	Height	Depth	Mounting Center to Top	Lamping	C-UL Rating
VIS-4	4"	10"	4"	5"	1-60W, Candle	Incand. Dry
VIS-7	6 1/2"	10"	4"	5"	2-60W, Candle	Incand. Dry
VIS-8	5 1/8"	7 7/8"	4 1/4"	4"	1-100W, Medium	Incand. Dry
VIS-10	6 5/8"	10"	4 5/8"	5"	1-100W, Medium	Incand. Dry
VIS-12	6 5/8"	12"	4 5/8"	6"	1-100W, Medium	Incand. Dry

Vintage

Wall Mount, Ceiling Mount & Pendants



VIB-6CLR-BZ
 Frame: VIB-6
 Glass: Clear (CLR)
 Finish: Bronze (BZ)



VISH-12CLR-BZ
 Frame: VISH-12
 Glass: Clear (CLR)
 Finish: Bronze (BZ)



VICM-12CLR-BZ
 Frame: VICM-12
 Glass: Clear (CLR)
 Finish: Bronze (BZ)



VISH-6CLR-BZ
 Frame: VISH-6
 Glass: Clear (CLR)
 Finish: Bronze (BZ)



Specifications

Frame	Width	Height	Depth	Extension	Mounting Base	Mounting Center to Top	Lamping	C-UL Rating
VIB-6	6"	9"	7"		4" x 6"	3"	1-100W, Medium	Incand. Wet
VISH-6	6"	8 ½"		32"	4 ¼" sq.		1-100W, Medium	Incand. Damp
VISH-12	12"	16"		36"	4 ¼" sq.		4-60W, Candle	Incand. Dry
VICM-12	12"	7 ¼"			13 ½" sq.		2-60W, Medium	Incand. Damp



VIH-14-BZ
 Frame: VIH-14
 Finish: Bronze (BZ)



VIH-9-BZ
 Frame: VIH-9
 Finish: Bronze (BZ)



VIH-18-BZ
 Frame: VIH-18
 Finish: Bronze (BZ)

Specifications

Frame	Width	Height	Extension	Mounting Base	Lamping	C-UL Rating
VIH-9	9"	13 3/4"	51 1/4"	4 1/4" sq.	3-60W, Candle	Incand. Damp
VIH-14	14"	17 5/8"	55"	4 1/4" sq.	4-60W, Candle	Incand. Dry
VIH-18	18"	21 1/2"	59"	4 1/4" sq.	4-60W, Candle	Incand. Dry





Product Information

Made in the U.S.A.: All Arroyo Craftsman fixtures are manufactured at our factory in Baldwin Park, CA.

Limited Warranty: All materials and component parts are warranted to be free from defects in materials and workmanship for a period of one year from date of purchase. The liability is expressly limited to the repair or replacement of such parts by Arroyo Craftsman, where in their opinion, damage is caused by defect and not misuse or incorrect installation.

Please note that free-hanging and some wall mount fixtures may not be suitable for high wind areas (options available). Arroyo Craftsman assumes no responsibility for improper selection or installation of its products.

No claims for labor or other charges at the job site will be allowed, unless specifically authorized in writing by Arroyo Craftsman. This warranty is automatically voided if any unauthorized repairs or alterations are made.

Voltage: Arroyo Craftsman fixtures with 110 line voltage are equipped with porcelain, medium or candelabra based sockets. Arroyo Craftsman fixtures wired for low voltage application require a 12 volt transformer; supplied by others.

TITLE 24/GREEN OPTION: All Arroyo Craftsman fixtures using a medium based socket may be specified with an optional GU24 based fluorescent socket for energy efficiency and Title 24 compliance.

U.L. Listed: Underwriters Laboratories is a nationally recognized safety testing agency. Our fixtures conform to U.L. Standards, tested as required, and bear the U.L. listing mark. Fixtures can be supplied with C-U.L. mark for Canada.

Safety and Maintenance Warning: Line voltage fixtures in this catalog must be grounded in accordance with your local codes or the National Electric Code. Failure to take these steps may result in serious personal injury.

To maintain light efficiency and prevent excessive heat build-up, do not exceed the maximum wattage listed on each fixture.

Freight Damage: Our products are fragile and sometimes damage occurs despite our packing efforts. If you receive damaged merchandise, please immediately notify the distributor, the shipping company, and retain all packing materials. We will repair or replace as quickly as possible.

Product Care: The metal and glass components of Arroyo Craftsman products should be cleaned using warm water and a soft cloth. Please refrain from using soaps or glass cleaners as some of their ingredients may damage the metal finish. The raw copper and mission brown finishes are not lacquered and therefore are sensitive to the natural oils produced by the skin. Handling these finishes with exposed skin may affect the appearance, because of this we recommend using gloves when handling items in these finishes. Arroyo Craftsman's oxidized finishes will continue to change and mature with age. This process can be slowed, but not completely prevented, by applying a clear paste wax to the metal components of the item. We do not recommend using paste wax on raw copper or mission brown because it may damage the finish. Please feel free to contact us with further inquiries concerning the care of your Arroyo Craftsman product.

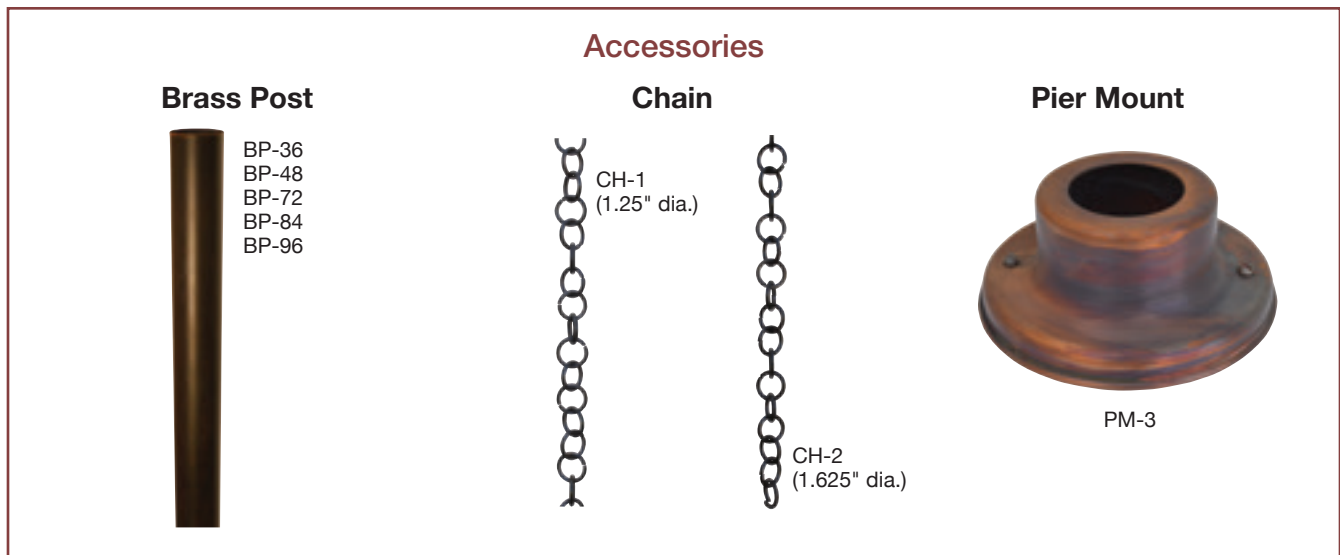

Index

Model	Page	Model	Page	Model	Page	Model	Page	Model	Page
AB-1	8	BEH-9	33	BSH-17L	25	ESH-7	61	GH-6L	79
ABB-7	7	BEP-7	34	BSP-6	29	ESH-9	61	GH-9	79
ABB-9	7	BEP-9	34	CAB-7	38	ESH-12	61	GH-9L	79
ABC-15	7	BG-FCE	162-164	CAB-7L	38	ESP-7	63	GH-18	79
ABH-7	7	BG-FST	162-164	CAB-9	38	ESP-9	63	GH-18L	79
ABH-9	7	BG-GLD	173-174	CAC-13	40	ETB-9	54	GLB-6	85
ACM-4	9	BG-MAG	173-174	CAC-16	40	ETB-11	54	GLB-9	85
AH-1	9	BG-MUS	162-164	CAC-19	40	ETB-14	54	GLC-16	86
AH-8	12	BG-ST5	162-164	CAH-7	39	ETC-9	55	GLS-6	86
AH-12	12	BG-WHT	173-174	CAH-7L	39	ETC-11	55	GLS-9	86
ANB-6	10	BH-6	22	CAH-9	39	ETCH-21	56	GMB	83
ANB-8	10	BH-6L	22	CAP-7	41	ETCM-21	56	GMBL	83
ANH-6	10	BH-6S	22	CAP-7L	41	ETH-9	56	GP-9L	83
ANH-8	10	BH-7	22	CAP-9	41	ETH-11	56	GP-18	83
AS-1	8	BH-7L	22	CB-8	43	ETH-14	56	GS-9	77
AS-12	11	BH-8	22	CB-12	43	ETP-11	55	GS-9L	77
AS-16	11	BH-11	23	CB-15	43	EW-7	59	GSADA-12	77
AS-2	8	BH-11L	23	CC-8	46	EW-9	59	GSADA-9	77
AS-3	8	BH-14	23	CC-12	46	EW-12	59	GSH-6L	80
AS-8	11	BH-14L	23	CC-15	46	EW-16	59	GSH-9	80
ASH-1	9	BH-14TL	22	CCH-8/4	45	EXC-9	66	GSH-9L	80
ASH-12	12	BH-17	23	CH-1	191	EXH-9	66	GSP-6	83
ASH-8	12	BH-17L	23	CH-2	191	EXP-9	66	GSP-6L	83
AVB-6	14	BOC-14	35	CH-8	44	EXS-6	65	GW-9	78
AVB-8	14	BOH-8	35	CH-12	44	EXS-9	65	GW-9L	78
AVB-8L	14	BOP-8	35	CH-15	44	EXS-12	65	GW-18	78
AVC-6	15	BOW-5	35	CICH-8/3	45	FB-9L	72	GW-18L	78
AVC-8	15	BOW-8	35	CP-8	47	FB-9LSA	72	HAB-5	87
AVH-8	14	BOW-10	35	CP-12	47	FCH-9L/4	73	HAB-6	87
AVP-8	15	BP-6	29	CP-15	47	FH-9L	73	HAB-8	87
AWS-1	8	BP-6L	29	CRB-8	48	FIC-12	70	HAC-16	88
BAH-12	16	BP-7	29	CRB-10	48	FIC-16	70	HAH-5	88
BAW-10	16	BP-7L	29	CRC-8	49	FIC-20	70	HAH-8	88
BAW-6	16	BP-8	29	CRC-10	49	FICH-9L/3	73	HB-4L	94
BAW-8	16	BP-11	30	CRH-8	48	FIH-8	69	HB-4LW	94
BB-6	18	BP-11L	30	CRH-10	48	FIH-8L	69	HC-6	91
BB-6L	18	BP-14	30	CRP-8	49	FIH-10	69	HC-8	91
BB-6LW	19	BP-14L	30	CRP-10	49	FIH-10L	69	HC-8L	91
BB-6S	18	BP-17	30	CSH-8	44	FIP-8	71	HCH-4L/4-1	96
BB-6SW	19	BP-17L	30	CSH-12	44	FIP-8L	71	HCM-4L/1	97
BB-6W	19	BP-36	191	CSP-8	47	FIP-10	71	HCM-4L/2	97
BB-7	18	BP-48	191	DEB-6	53	FIP-10L	71	HCM-4L/4	97
BB-7L	18	BP-72	191	DEB-8	53	FIW-8	68	HCM-12	98
BB-7LW	19	BP-84	191	DEB-10	53	FIW-8L	68	HCM-14	98
BB-7W	19	BP-96	191	DEH-13	53	FIW-10	68	HCM-15	98
BB-8	18	BRB-8	36	DEH-17	53	FIW-10L	68	HCM-18	98
BB-8W	19	BRB-10	36	DH-4	52	FSH-9L	73	HCM-27	99
BB-11	20	BRC-8	37	DH-6	52	FW-9L	72	HCM-35	99
BB-11L	20	BRC-10	37	DH-8	52	GB-6	75	HCM-48	99
BB-14	20	BRH-10	36	DS-4	51	GB-6L	75	HH-4L	96
BB-14L	20	BRP-8	37	DS-6	51	GB-6LSA	76	HH-6	90
BB-14TL	18	BRP-10	37	DS-8	51	GB-6SA	76	HH-8	90
BC-11	28	BS-6LR	21	EB-7	58	GB-9	75	HH-8L	90
BC-11L	28	BS-6R	21	EB-9	58	GB-9L	75	HICH-4L/3	96
BC-14	28	BS-7LR	21	EB-12	58	GB-9LSA	76	HLB-24	95
BC-14L	28	BS-7R	21	EB-16	58	GB-9SA	76	HP-6	92
BC-17	28	BS-8R	21	EC-9	62	GB-18	75	HP-8	92
BC-17L	28	BSH-6	24	EC-12	62	GB-18L	75	HP-8L	92
BCM-6	27	BSH-6L	24	EC-16	62	GC-9	82	HS-8	95
BCM-6S/3	26	BSH-6S	24	EH-7	60	GC-9L	82	HS-10	95
BCM-8	26	BSH-7	24	EH-9	60	GC-18	82	HS-12	95
BCM-10	26	BSH-7L	24	EH-12	60	GC-18L	82	HS-14S	95
BCM-12	26	BSH-8	24	EH-16	60	GCH-9L/4	81	HSH-4L	96
BCMH-6	27	BSH-11	25	EMB	64	GCH-9L/4-1	81	HW-6	89
BCMH-20	27	BSH-11L	25	EMBL	64	GCM-7	81	HW-8	89
BEB-7	33	BSH-14	25	EP-7	63	GCM-8	81	HW-8L	89
BEB-9	33	BSH-14L	25	EP-9	63	GCM-12	81	INB-8GR	100
BEC-15	34	BSH-14TL	24	EP-12	63	GCM-18	81	INB-8MR	102
BEH-7	33	BSH-17	25	EP-16	63	GH-6	79	INB-10GR	100

Model	Page	Model	Page	Model	Page	Model	Page	Model	Page
INB-10MR	102	LV36-B6S	32	MW-6	116	PH-12	154	SGP-10	170
INC-8GR	101	LV36-B8R	32	MW-7	116	PH-15	154	SH-1	174
INC-8MR	103	LV36-M5	123	MW-10	116	PH-18	154	SLB-2	173
INC-10GR	101	LV36-M6	123	MW-15	116	PH-18/36	154	SLB-3	173
INC-10MR	103	LVW-B8R	32	NAB-8	129	PIH-11	150	SLB-4	173
INH-8GR	100	LYC-14	113	NAB-10	129	PIH-12	153	SS-1	174
INH-8MR	102	LYCH-26	113	NAC-10	130	PIH-15	153	SSH-1	174
INH-10GR	100	LYH-7	113	NAH-10	129	PIH-16	150	SYH-12	175
INH-10MR	102	LYP-7	113	NAP-10	130	PIH-18	153	SYW-7	175
INP-8MR	103	LYW-5	112	NB-9	132	PM-3	191	SYW-7L	175
INP-10GR	101	LYW-7	112	NB-9L	132	PRC-15	157	SYW-9	175
INP-10MR	103	LYW-9	112	NB-14	132	PRW-7	157	TRB-9	177
KAB-7	105	MB-5	115	NB-14L	132	PRW-7L	157	TRB-12	177
KAB-9	105	MB-6	115	NC-9	136	PRW-9	157	TRB-16	177
KAB-12	105	MB-7	115	NC-9L	136	PS-12	153	TRC-9	179
KAC-7	106	MB-10	115	NC-14	136	PS-15	153	TRC-12	179
KAC-9	106	MB-12	125	NC-14L	136	PSA-1	150	TRC-16	179
KAC-12	106	MB-15	115	NH-9	134	PSH-12	155	TRH-9	178
KAH-9	105	MB-17	125	NH-9L	134	PSH-15	155	TRH-12	178
KAP-7	107	MB-20	125	NH-14	134	PSH-18	155	TRH-16	178
KAP-9	107	MC-7	120	NH-14L	134	PTL-9L	149	TRP-9	180
KAP-12	107	MC-10	120	NH-17	134	PTL-11	149	TRP-12	180
KB-9	108	MC-12	128	NOB-6	138	PTL-12	152	TRP-16	180
KB-12	108	MC-15	120	NOB-8	138	PTL-15	152	VB-7	182
KC-9	109	MC-17	128	NOC-6	139	PTL-16	149	VB-7NR	182
KC-12	109	MC-20	128	NOC-8	139	RB-1	162	VB-9	182
KH-9	108	MC-24	128	NOH-6	138	RB-6	159	VB-9NR	182
KH-12	108	MC-30	128	NOH-8	138	RB-6W	160	VB-11	182
KP-9	109	MC-36	128	NP-9	137	RB-8	159	VB-11NR	182
KP-12	109	MCH-12/4	127	NP-9L	137	RB-8W	160	VCH-7/5	184
LAB-6	110	MCM-7	117	NP-14	137	RB-10	159	VH-7	184
LAB-9	110	MCM-8	117	NP-14L	137	RB-10W	160	VH-7NR	185
LAB-12	110	MCM-12	117	NS-14	133	RCH-4	163	VH-9NR	185
LAC-9	111	MCM-18	117	NS-14L	133	RCH-4U	163	VH-11NR	185
LAC-12	111	MCM-5/2	117	NS-9	133	RCM-1	164	VIB-5	186
LAH-9	110	MCM-5/4	117	NS-9L	133	RCM-2	164	VIB-6	188
LAH-12	110	MCM-6/2	117	NSH-9	135	RCM-4	164	VIB-6L	186
LAP-9	111	MCM-6/4	117	NSH-9L	135	RH-1	163	VIB-6TL	186
LAP-12	111	MH-5	118	NSH-14	135	RH-6	161	VIB-9	186
LV12-8R	64	MH-6	118	NSH-14L	135	RH-8	161	VICM-12	188
LV12-B6	31	MH-7	118	NSH-17	135	RH-10	161	VIH-9	189
LV12-B6L	31	MH-10	118	OPB-7	141	RS-1	162	VIH-14	189
LV12-B6S	31	MH-12	126	OPB-9	141	RS-2	162	VIH-18	189
LV12-B8R	31	MH-15	118	OPB-11	141	RS-3	162	VIS-4	187
LV12-M5	123	MH-17	126	OPC-11	143	RSH-1	163	VIS-7	187
LV12-M6	123	MH-20	126	OPC-15	143	SAB-7	171	VIS-8	187
LV18-8R	64	MH-24	126	OPH-7	142	SAB-9	171	VIS-10	187
LV18-B6	31	MH-30	126	OPH-9	142	SAB-11	171	VIS-12	187
LV18-B6L	31	MH-36	126	OPH-11	142	SAH-9	171	VISH-6	188
LV18-B6S	31	MMB	123	OPP-9	143	SAP-9	171	VISH-12	188
LV18-B8R	31	MMBL	123	OPP-11	143	SB-1	174	VS-7	183
LV18-M5	123	MP-5	121	ORB-8	144	SCCH-21	167	VS-7NR	183
LV18-M6	123	MP-6	121	ORB-10	144	SCCM-15	167	VS-9	183
LV24-8R	64	MP-7	121	ORH-8	144	SCCM-21	167	VS-9NR	183
LV24-B6	31	MP-10	121	ORH-10	144	SCH-12	166	VS-11	183
LV24-B6L	31	MP-12	127	PCH-18	156	SCLB-18	166	VS-11NR	183
LV24-B6S	31	MP-17	127	PCH-36	156	SCLB-30	166	VSH-7NR	185
LV24-B8R	31	MPC-5	120	PDB-9	145	SCW-12	165	VSH-9NR	185
LV24-M5	123	MPC-6	120	PDB-12	145	SCW-16	165	VSH-11NR	185
LV24-H4	94	MPC-7	120	PDB-17	145	SDB-6	172		
LV24-M6	123	MS-8	116	PDC-9	147	SDB-10	172		
LV27-B6	32	MS-10	116	PDC-12	147	SDC-13	172		
LV27-B6L	32	MS-12	116	PDC-17	147	SDCM-13	172		
LV27-B6S	32	MSH-10	119	PDH-12	146	SGB-7	170		
LV27-B8R	32	MSH-6	119	PDP-12	147	SGB-10	170		
LV27-M5	123	MSH-7	119	PDW-9	146	SGC-10	170		
LV27-M6	123	MSP-5	122	PDW-12	146	SGCH-20	169		
LV36-B6	32	MSP-6	122	PDW-17	146	SGH-7	169		
LV36-B6L	32	MSP-7	122	PFL-18	152	SGH-10	169		

American Lighting Brands

Arroyo Craftsman Framburg House of Troy Scatchard Stoneware Thumprints



FRAMBURG



Scatchard Stoneware



Made in the U.S.A.

4509 Littlejohn Street, Baldwin Park, CA 91706
phone: 626-960-9411 fax: 626-960-9521
www.arroyocraftsman.com